



Read this document carefully before using this device. The guarantee will be expired by device damages if you don't attend to the directions in the user manual. Also we don't accept any compensations for personal injury, material damage or capital disadvantages.

ENDA EPC9513 Series Programmable Profile Controller

Thank you for choosing EPC9513 series programmable profile controller.

- * 96x96mm sized.
- * 3,5 inches TFT , graphic and 5 digit display.
- * Selectable TC, RTD, NTC, R, mA, V or mV inputs.
- * Input offset feature.
- * 32 point linearization for analog inputs.
- * Selectable relay, SSR, motorized valve or analog outputs.
- * Selectable , input proportional transmitter output(mA or V).
- * 50ms sampling time.
- * PID control.
- * PID selftune.
- * PID auto-tune.

Selftune automatic PID calculation or manually enter PID parameters if known.

- * Soft-Start feature.
- * 24Vdc for sensor supply.
- * 16 program and 8 step for profile control.
- * Selectable Single Setpoint Mode or Profile Control Mode.
- * Digital inputs for profile control.
- * In case of sensor failure manually , periodical or auto-periodical control can be selected.
- * Security levels for menu and configuration pages.
- * RS485 ModBus protocol communication feature.(optional)
- * CE marked according to European Norms.

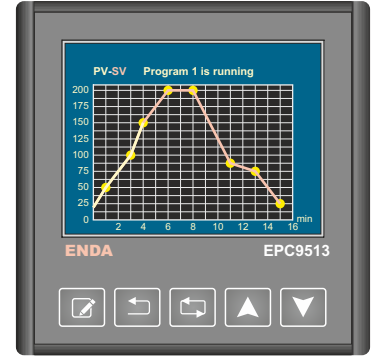

RoHS Compliant

Analog Inputs						
Input Type	Range	Accuracy	Input Resist.	Cable Color	Standart	
TC	B (Pt30Rh-Pt6Rh)	200,0 ... 1800,0°C 392,0 ... 3272,0°F	% ±0.1 and ±2°C (3,6°F)	Ri > 100kΩ	+ undefined - white	EN 60584
	E (NiCr-Con)	-100,0 900,0°C -148,0 ... 1652,0°F	% ±0.1 and ±0,5°C (1°F)		+ purple - white	
	J (Fe-Con)	-100,0 900,0°C -148,0 ... 1652,0°F	% ±0.1 and ±0,5°C (1°F)		+ black - white	
	K (NiCr-Ni)	-100,0 ... 1300,0°C -148,0 ... 2372,0°F	% ±0.1 and ±0,5°C (1°F)		+ green - white	
	L (Fe-Con)	-100,0 900,0°C -148,0 ... 1652,0°F	% ±0.1 and ±1,5°C (2,7°F)		+ red - blue	DIN43710
	N (NiCrSi-NiSi)	-200,0 ... 1300,0°C -328,0 ... 2372,0°F	% ±0.1 and ±0,5°C (1°F)		+ lilac - white	EN 60584
	R (Pt13Rh-Pt)	0,0 ... 1700,0°C 32,0 ... 3092,0°F	% ±0.1 and ±1°C (1,8°F)		+ orange - white	
	S (Pt10Rh-Pt)	0,0 ... 1700,0°C 32,0 ... 3092,0°F	% ±0.1 and ±1°C (1,8°F)		+ orange - white	
	T (Cu-Con)	-250,0 300,0°C -418,0 572,0°F	% ±0.1 and ±0,5°C (1°F)		+ brown - white	
	U (Cu-Con)	-200,0 400,0°C -328,0 752,0°F	% ±0.1 and ±0,5°C (1°F)		+ red - brown	DIN43710
RTD	Pt100	-200,0 850,0°C -328,0 ... 1562,0°F -100,00 ... 160,00°C -148,00 ... 320,00°F	% ±0.1 and ±0,5°C (1°F)	Ri > 100kΩ	Sensor current 250µA EN 60751	
NTC	NTC	-60,0 150,0°C -76,0 302,0°F	% ±0.1 and ±0,5°C (1°F)	Ri > 100kΩ		
mA	0 - 20mA 4 - 20mA	-32768 ... 32767	% ±0.1 and ±1 digit	Ri = 50Ω		
mV	0 - 150mV	-3276,8 ... 3276,7	% ±0.1 and ±20µV	Ri > 100kΩ		
V	0 - 5V 1 - 5V 0 - 10V	-327,68 ... 327,67 -32,768 ... 32,767	% ±0.1 and ±1 digit	Ri > 100kΩ		
Ω	0 - 550Ω 0 - 10kΩ		% ±0.2 and ±0.1Ω % ±0.5 and ±10Ω	Ri > 100kΩ	Sensor current 250µA	

DIGITAL INPUTS (In order to use for profile control process)	
Start-Stop Input Pause-Resume Input Previous Program Input Next Program Input	5V or 30V pulse , Ri=100kΩ

OUTPUTS	
Control/A.3/Valve On	250V AC, 2A . Selectable as NO+NC.10.000.000 switch without load and 200.000 switch under 250V AC 2A (resistive load)
Alarm 1	250V AC, 2A . Selectable as NO+NC.10.000.000 switch without load and 200.000 switch under 250V AC 2A (resistive load)
Alarm 2/Valve Off	250V AC, 2A . Selectable as NO.10.000.000 switch without load and 200.000 switch under 250V AC 2A (resistive load)
SSR	Max. 40mA , 0 - 12Volt , short-circuit protection.
mA	0 - 20mA or 4 - 20mA DC. % ±0,5 (Max. load resistance is 750Ω.)
V	0 - 10V DC, % ±0,5 Max. 30mA (short-circuit protection.)

ELECTRICAL CHARACTERISTICS	
Supply	90-250V AC, 50/60Hz
Power consumption	Max. 7VA
Wiring	2.5mm ² screw-terminal
EMC	EN 61326-1: 2013
Safety requirements	EN 61010-1: 2010 (Pollution degree 2 , overvoltage category II)

ENVIRONMENTAL CONDITIONS	
Ambient/storage temp.	0 ... +50°C/-25 ... 70°C
Max. Relative humidity	Relative humidity 80% for temperatures up to 31°C , decreasing linearly to 50% relative humidity at 40°C.
Rated pollution degree	According to EN 60529 Front panel : IP65 , Rear panel : IP20
Height	Max. 2000mm

Do not use the device in locations subject to corrosive and flammable gases.

HOUSING	
Housing type	Suitable for flush-panel mounting.
Dimensions	G96xY96xD81mm
Weight	Approx. 400g.
Enclosure material	Self extinguishing plastics.

While cleaning the device , solvents(thinner,gasoline,acid etc.) or corrosive materials must not be used.



SİSEL MÜHENDİSLİK ELEKTRONİK SAN. VE TİC. A.Ş.
Şerifali Mah. Barbaros Cad. No:18 Y.Dudullu 34775
ÜMRANİYE/İSTANBUL-TÜRKİYE
Tel : +90 216 499 46 64 Pbx. Fax : +90 216 365 74 01
url : www.enda.com.tr



DIMENSIONS

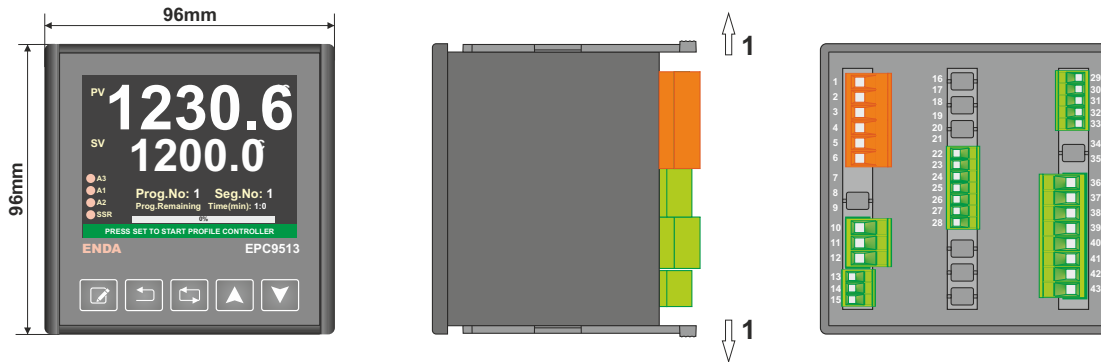

PANEL CUT-OUT

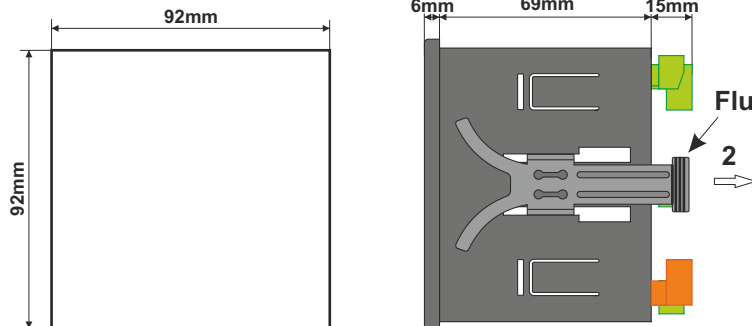

Flush mounting clamp

For removing the device from panel :
- While pressing both flush mounting clamps of the device in direction 1 , pull it in direction 2.

Not :

- 1) Panel thickness should be maximum 7mm.
- 2) If there is no 60mm free space at the back side of the device , it would be difficult to remove it from panel.

CONNECTION DIAGRAM



ENDA EPC9513 is intended for installation in control panels. Make sure that the device is used only for intended purpose. The electrical connections must be carried out by a qualified staff and must be according to the relevant locally applicable regulations. During an installation , all of the cables that are connected to the device must be free of electrical power. The device must be protected against inadmissible humidity , vibrations , severe soiling and make sure that the operation temperature is not exceeded. The cables should not be close to the power cables or components.

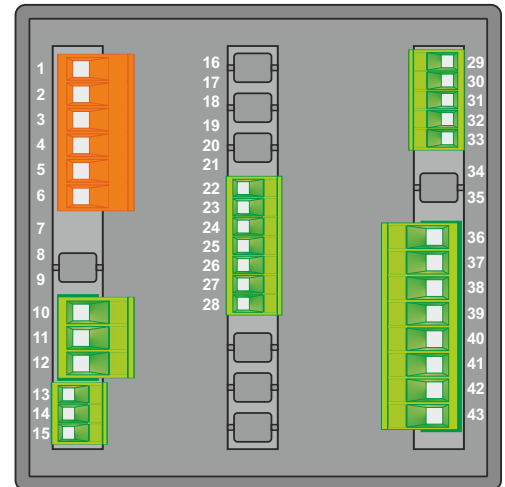
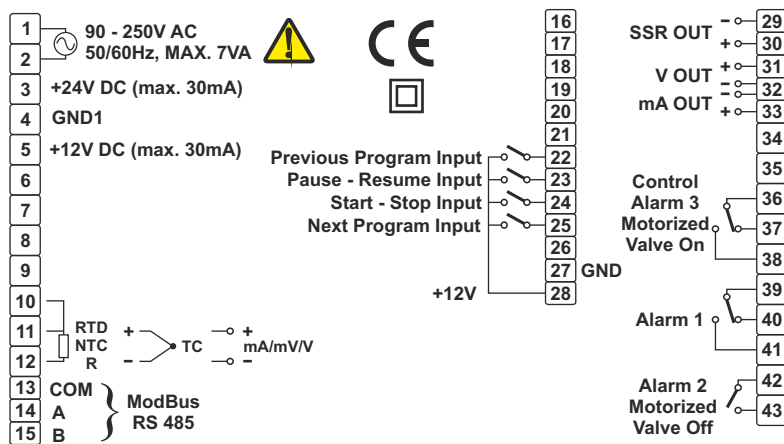

SUPPLY VOLTAGE

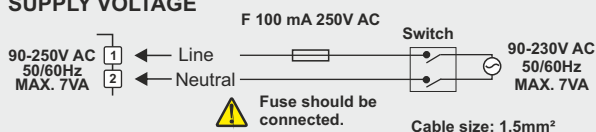

Logic output of the instrument is not electrically insulated from the internal circuits. Therefore , when using grounding thermocouple , do not connect the logic output terminals to the ground.

- Not :
- 1) Main supply cords shall meet the requirements of IEC 60227 or IEC60245.
 - 2) In accordance with safety regulations, the power supply switch shall bring the identification of the relevant instrument and it should be easily accessible by the operator.

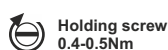







Holding screw
0.4-0.5Nm

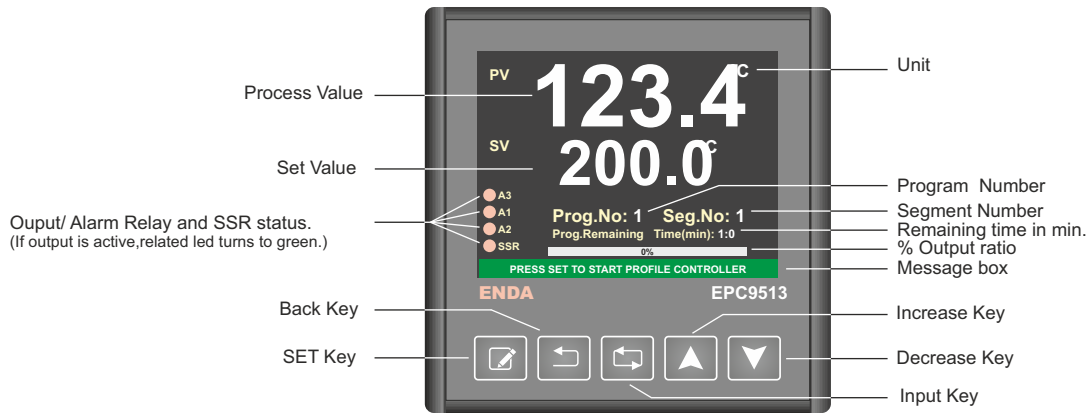

Equipment is protected throughout
by DOUBLE INSULATION.

HOME SCREEN



-  **SET Key :** Start/Stop profile controller in "Profile Controller Mode", Select/Unselect parameter for increase/decrease parameter value in "Programming Mode". Change SV in "Single Setpoint Mode".
-  **Back Key :** Return previous page in "Programming Mode".
-  **Enter Key :** Enter main menu and open sub pages and transition between sub pages in "Programming Mode". Pause/Resume profile controller in "Profile Controller Mode".
-  **Increase Key :** Transition between parameters (when parameter background is red) and increase selected parameter value (when parameter background is green) in "Programming Mode".
-  **Decrease Key :** Transition between parameters (when parameter background is red) and decrease selected parameter value (when parameter background is green) in "Programming Mode".



- NOTE 1 :** Device must be in "Profile Control Mode" in order to start/stop profile control by pressing Set Key.
- NOTE 2 :** When device in "Single Setpoint Mode", **Prog.No**, **Seg.No** ve **Prog.Remaning Time(min)** informations are not shown on home screen.
- NOTE 3 :** If Increase Key is held down while the device is powered up, factory parameters will be restored.
- NOTE 4 :** "Single Setpoint Mode" can be selected under "Profile Controller Configuration Page" sub menu, device make a control related to SV, which can be adjusted on home screen in "Single Setpoint Mode".

Adjusting Device Set Value in Single Setpoint Mode

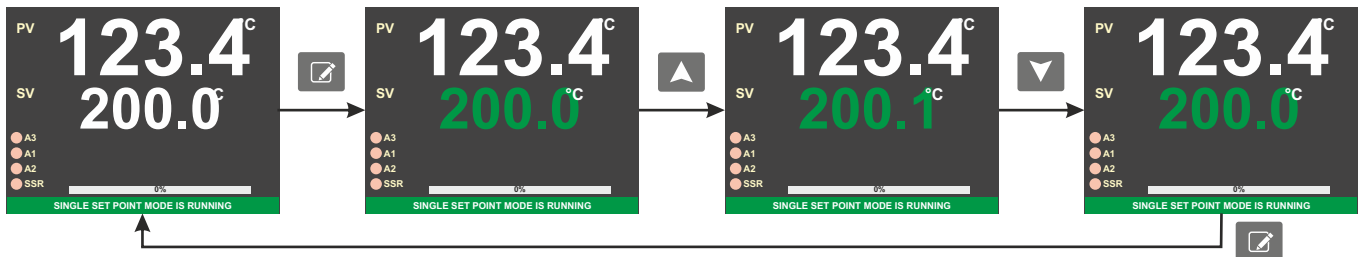

If Set Key pressed once, SV's color will be green. In this case SV is adjusted by pressing Increase/Decrease keys.
If Set Key pressed again or by waiting 3 seconds, SV's color will be white on home screen.

Profile Control Mode

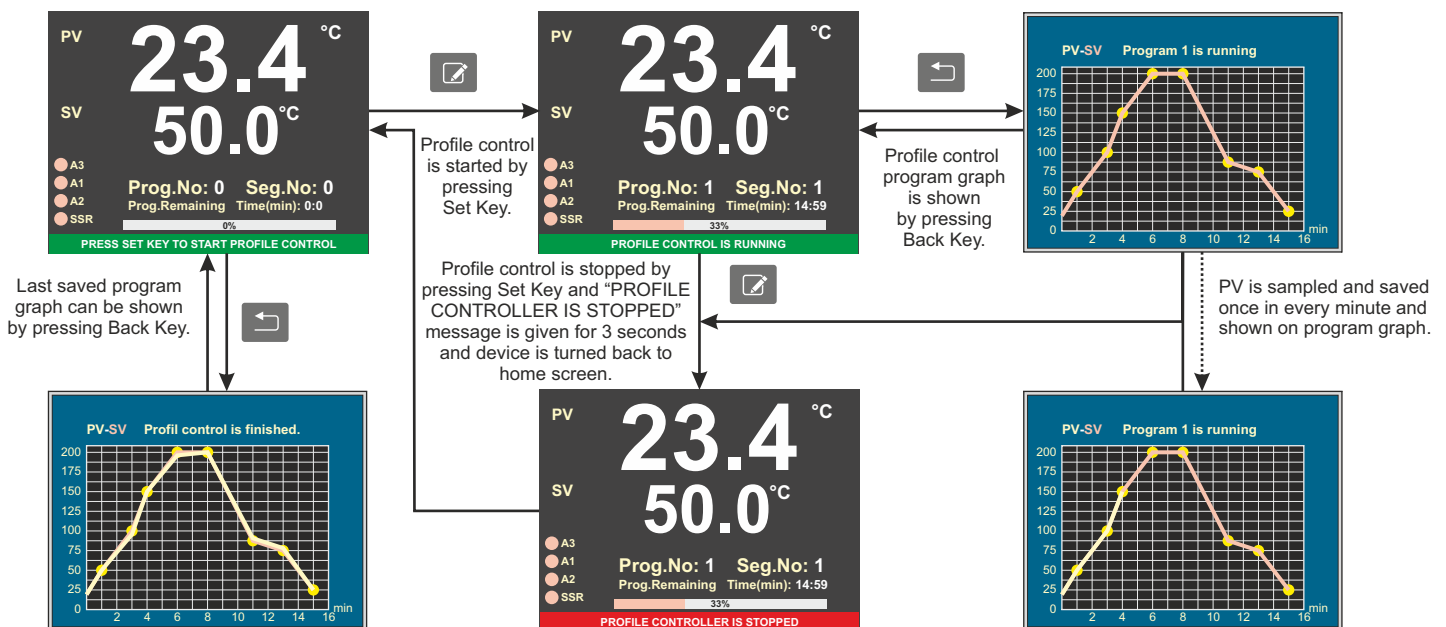

Home Screen

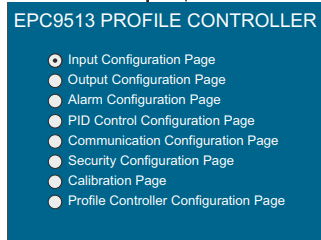
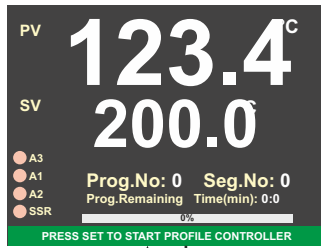

Main menu is opened and "Programming Mode" is started by pressing Enter Key for 2 seconds.

Desired sub menu is selected by pressing Increase/Decrease Keys.

Selected sub menu is opened by pressing Enter Key.
Selected sub menu can be opened if permission is given from "Security Configuration Page".

If Back Key is pressed or by waiting 10 seconds, parameters will be saved and device turns back to home screen.

NOT 5 : If power failure is occurs while device is programming, parameters won't be saved.

Programming Inputs (Input Configuration Page)

Desired parameter is selected by pressing Increase/Decrease Keys. Background of selected parameter turns red.

If SET Key is pressed, background of selected parameter turns to green and selected parameter can be adjusted to desired value.

If SET Key is pressed again, background of selected parameter turns to red and exits from parameter adjustment.

If Back Key pressed or by waiting 10 seconds, Input Configuration Page is closed and device turns back to main menu.

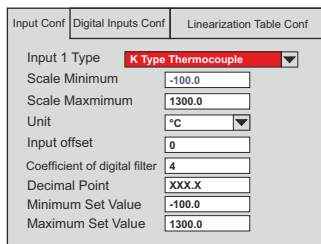
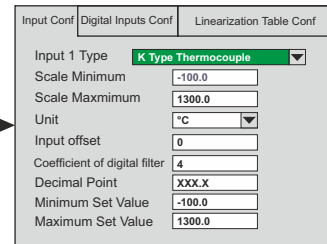
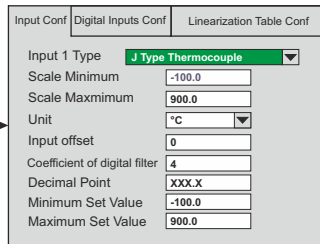
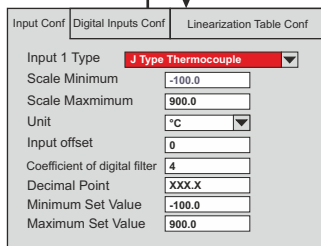

Input 1 Type :
B, E, J, K, L, N, R, S, T, U, Pt100, NTC, 0-20mA, 4-20mA, 0-5V, 1-5V, 0-10V, 0-150mV, 0-550Ω, 0-10kΩ

Maximum Set Value :
Adjustable between Scale Maximum and Minimum Set Value.

Input offset :
Adjustable between -99 ... 99.

Coefficient of digital filter :
1=200ms and it is device sampling time. Adjustable between 1 ... 32. Value of parameter should be increased in interference.

Scale(Scale Min./Max.) :
Adjustable between -32768 ... 32767 (Just for mA, V, mV, Ω, kΩ)

Unit :
°C, °F, bar, %RH, Hz, mA, A, mV, V, Ohm, kOhm, %, g, kg, cm, m, m/s, m/min, km/h, cm3/s, m3/h, l/s, l/min, l/h pH, EC (Just for mA, V, mV, Ω, kΩ)

Decimal Point :
According to range table, 1, 2 and 3 digit can be selected.

Minimum Set Value :
Adjustable between Scale Minimum and Maximum Set Value.

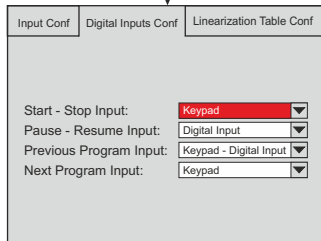

Digital Inputs : Start/Stop, Pause/Resume, Next/Previous Program processes can be made by digital inputs or device keypad.

If process will be performed only by Keypad, "Keypad" must be selected.

If process will be performed only by Digital Input, "Digital Input" must be selected.

If process will be performed both by Keypad and Digital Input, "Keypad and Digital Input" must be selected.

Start/Stop : Start-Stop Input and/or SET key.

Pause/Resume : Pause-Resume Input and/or Back key.

Previous program : Previous Program Input and/or Increase key.

Next program : Next Program Input and/or Decrease key.

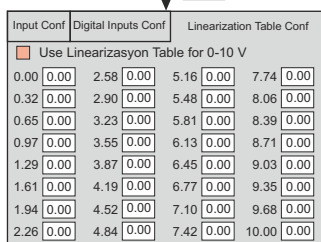

Linearization Table Conf :

If input type is selected as mA, V, mV, Ω or kΩ, linearization can be done at 32 points.

Use Linearization Table for 0-10 V can be activated by pressing keys respectively.

Corresponding values of input signals must be entered to table in order to linearize at 32 points.

Programming Outputs(Output Configuration Page)

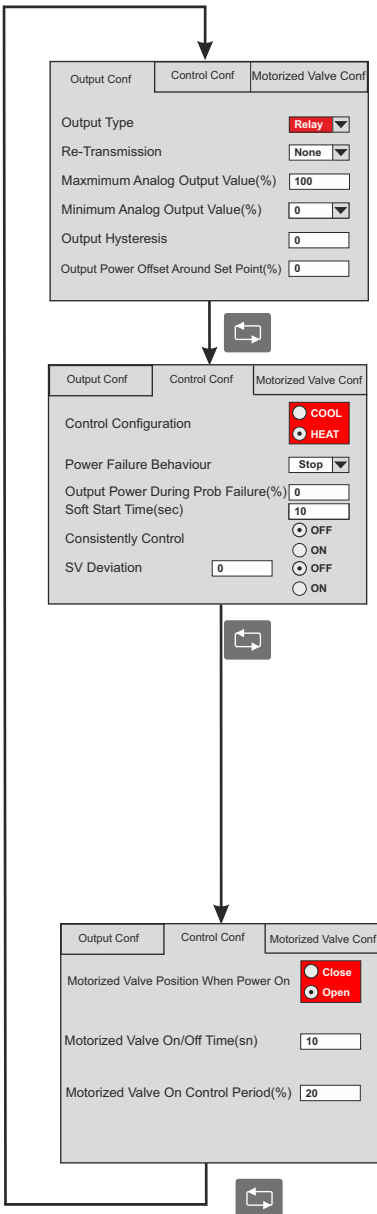

Output Type : Relay, SSR, Motorized Valve, 0-20mA, 4-20mA or 0-10V. If relay is not selected for output type , relay can be configured as Alarm3 or motorized valve.

Re-Transmission : If output type is selected as relay or SSR , re-transmission can be selected as a 0/4-20mA or 0-10V. If output type is selected as a 0/4-20mA , re-transmission can be selected as a 0-10V. If output type is selected as 0-10V , re-transmission can be selected as a 0/4-20mA.

Maximum Analog Output Value : % maximum analog output value.

Minimum Analog Output Value : % minimum analog output value.

Output Hysteresis : Adjustable between 0... 50. **(If Proportional Band selected 0.0 , ON-OFF control and output hysteresis will be active.)**

Output Power Offset Around Set Point : Output power offset around SV according to error. In order to reach to SV fast.
 $TotalOutput(\%) = system\ output(\%) + (100 / Proportional\ Band) * error * OutputPowerOffset / 100.$

Control Configuration : Selectable as Cool/Heat control. **The cooling control is only ON-OFF control (For Cooling control. Proportional Band must be 0.0).**

Power Failure Behaviour : If power failure occurs when profile control is running and device is powered on after power failure:
 - Stop : Profile control stops and turns to initial state.

- Step : Profile control resumes from the beginning of the current step before power fail.

- Time : Finds the remaining time of the current step and completes that step.

- Temp: If the temperature decreases in case of power failure, when the device power on again, it determines which step corresponds to the current temperature (regardless of which step it was during the power cut) and calculates how much time is remaining for that step to complete. The device then continues operating from that step.

Output Power During Prob Failure(%): Adjustable between %0 ... %100. Output will continue in case of prob failure.

Soft Start Time(sec) : Adjustable between 0 ... 200 seconds.

If device is in profile control mode , programmed segments of profile control starts according to soft start time.

If device is in "Single Setpoint Mode" , device starts to control according to soft start time after device is powered on.

Consistently Control : When profile control is finished ; If OFF is selected , profile control stops and turns to initial state. If ON is selected , profile control continues to control at last set value.

SV Deviation : End of the every profile control step , If difference between process value and set value is bigger than SV Deviation value ($SV - PV > SV\ Deviation$) then time countdown is paused and control remains at last set value until difference between process value and set value is smaller than SV Deviation value ($SV - PV < SV\ Deviation$). SV Deviation process can be enabled/disabled with ON/OFF option.

Motorized Valve Position When Power On: It provides to configuration of location of motorized valve when device power on.

Motorized Valve On/Off Time (sn): It can configuration between 2-300 seconds

Motorized Valve Control Period(%): Motorized valve configurations off time during on/off. This time gets by percent on/off time of motorized valve. If this time is less than 2 seconds, time will be 2 seconds automatically.

Programming Alarms(Alarm Configuration Page)

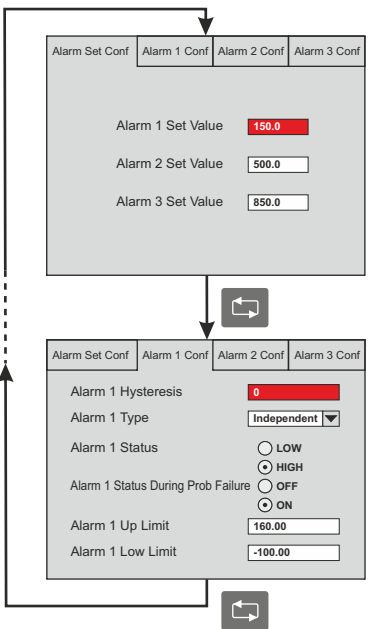

Alarm 1 Set Value : Adjustable between Alarm 1 Up Limit and Alarm 1 Low Limit.

Alarm 2 Set Value : Adjustable between Alarm 2 Up Limit and Alarm 2 Low Limit.

Alarm 3 Set Value : Adjustable between Alarm 3 Up Limit and Alarm 3 Low Limit.
 (In order to use Alarm 3 , **Output Type** parameter must be different from **Relay** otherwise Alarm 3 will be unavailable and Alarm 3 Conf page will be hidden.

Alarm 1 Hysteresis : Adjustable between 0 ... 50.

Alarm 1 Type : Independent alarm, Deviation alarm, Band alarm, Band Alarm with Inhibition or Profil control alarm can be selected. (In order to select Profile control segment alarms , Alarm 1 segments in Alarm Conf sub page of Profile Controller Configuration Page should be selected.

Alarm 1 Status : For the Independent alarm, Band alarm or Band Alarm with Inhibition to be active below the set value LOW must be selected , to be active above the set value HIGH must be selected. If LOW is selected for Band alarm , alarm will be activated in band. If HIGH is selected , alarm will be activated out of band.

Alarm 1 Status During Probe Failure : For the alarm to be active in case of prob failure ON must be selected. For the alarm to be inactive in case of prob failure OFF must be selected.

Alarm 1 Up Limit : Adjustable between Scale Maximum and Alarm 1 Low Limit.

Alarm 1 Low Limit : Adjustable between Scale Minimum and Alarm 1 Up Limit.

Alarm 2 "Alarm 2 Conf" and Alarm 3 "Alarm 3 Conf" are programmed in the same way.

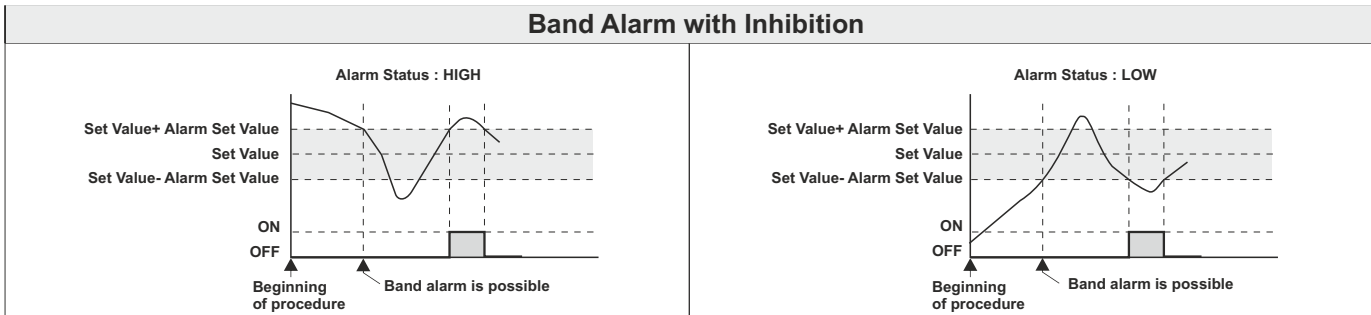
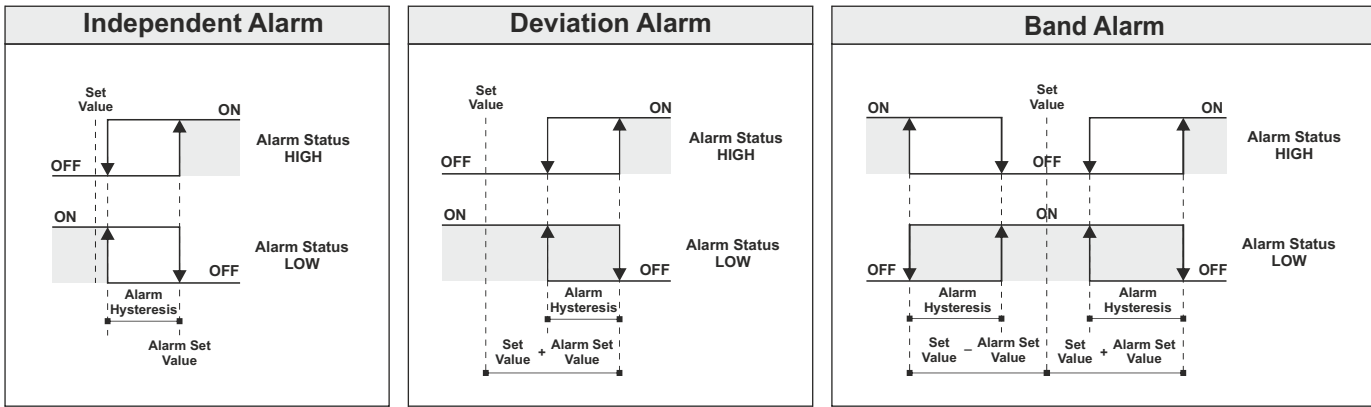

Programming

PID Control Conf

Proportional Band (%)

Integral Time (min)

Derivative Time (min)

Control Period (sec)

Auto Tune OFF ON

Programming PID Control (PID Control Configuration Page)

Proportional Band (%) : Adjustable between %0.0 ... %100.0.

If proportional band is selected 0.0 , ON-OFF control will be activated.

Integral Time (min) : Adjustable between 0.0 ... 100.0 minute.

Derivate Time (min) : Adjustable between 0.0 ... 25.0 minute.

Control Period (sec) : Adjustable between 0 ... 250 second.

Auto Tune : It allows to improve PID parameters after Self Tune. In normal operation, it provides the best control by automatically changing the PID parameters in case the measured value oscillates. If Auto Tune ON is selected, it is active and the display shows AUTO TUNE RUNNING until Auto Tune is completed. Auto Tune OFF must be selected to stop the Auto Tune operation.

PID Self Tune :

Self Tune is started by selecting with keys and pressing by key. SELF TUNE IS

STARTED and SELF TUNE IS RUNNING messages is shown respectively.

If key is pressed, SELF TUNE IS STOPPED message is shown and selftune is stopped and device turns back to home screen.

When Self Tune process is successful:

- SELF TUNE IS FINISHED, PRESS BACK TO EXIT message is shown and waits for user intervention in profile control mode.

- SELF TUNE IS FINISHED, SINGLE SETPOINT IS RUNNING message is shown and continues to control.

In order to start Selftune process PV must be smaller than %60 of SV , otherwise SELF TUNE IS STARTED and SELF TUNE IS STOPPED messages are shown respectively and home screen returned.

User must wait until PV drops under %60 of SV and start selftune again.

Modbus Conf

Modbus Communication OFF ON

Device Address

Baudrate

Programming ModBus (Communication Configuration Page)

Modbus Communication : If parameter is selected ON modbus will be active , otherwise will be inactive.

Device Address : Adjustable between 1 ... 247

Baudrate : 4800, 9600, 19200, 38400 or 57600.

Security Code

Input Configuration Page Visibility

Output Configuration Page Visibility

Alarm Configuration Page Visibility

PID Control Configuration Page Visibility

Communication Configuration Page Visibility

Calibration Page Visibility

Profile Controller Configuration Page Visibility

Enter security code in order to change page visibilities.

Programming Keypad Security Level(Security Configuration Page)

Security Code : In order to change security configuration , Security Code must be entered 123.

Input Configuration Page Visibility : Yes, No or None.

Output Configuration Page Visibility : Yes, No or None.

Alarm Configuration Page Visibility : Yes, No or None.

PID Control Configuration Page Visibility : Yes, No or None.

Communication Configuration Page Visibility : Yes, No or None.

Calibration Page Visibility : Yes or None.

Profile Controller Configuration Page Visibility : Yes, No or None.

No : Page can be opened , parameters can not be changed.

Yes : Page can be opened , parameters can be changed. None : Page can not be opened.

Programming

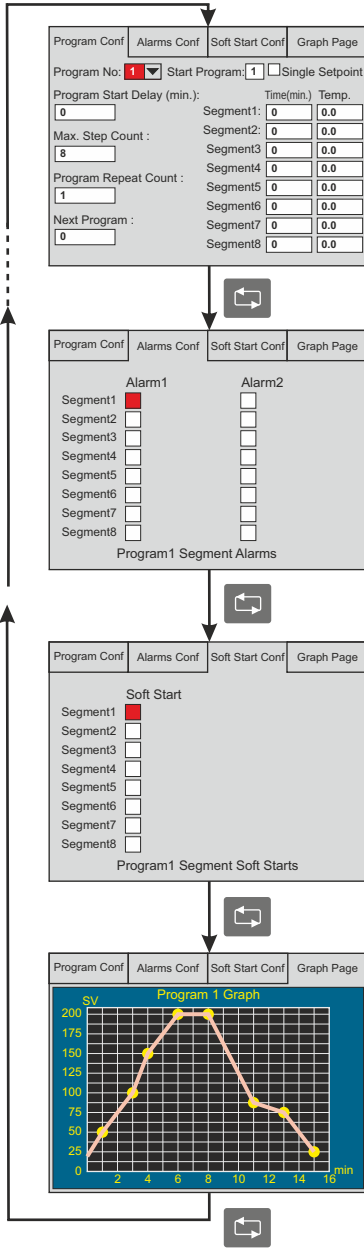

Programming Profile Controller (Profile Controller Configuration Page)

Program No : Adjustable between 1 ... 16.
Start Program : Adjustable 1 ... 16.
Single Setpoint : If checkbox is selected , single set point will be activated.(In this case profile controller is inactive)
Program Start Delay(min.) : Adjustable between 0 ... 180.
Max. Step Count : Adjustable between 1 ... 8.
Program Repeat Count : Adjustable between 1 ... 8.
Next Program : Adjustable between 0 ... 16. If 0 is selected , control will be stopped at end of the program.
Segment1/Time(min.) : Adjustable between 0 ... 32000 min.
Segment1/Temp : Adjustable between Minimum Set Value and Maximum Set Value parameters.

2, 3 ... 8. Segments are programmed in the same way.

Segment1/Alarm1 : If checkbox is selected , Alarm1 will be activated.
Segment1/Alarm2 : If checkbox is selected , Alarm2 will be activated.

2, 3 ... 8. Segments are programmed in the same way.

If **Alarm Type** parameter is selected **profile control alarm** , Alarm1 and Alarm2 can be configured for the profile controller.

Soft Start Conf :

1. **Segment Soft Start** : If checkbox is selected , Soft Start will be activated.
 Value of **Soft Start Time parameter** will be used as a selected segment's soft start time.
 2, 3 ... 8. Segments are programmed in the same way.

Graph Page :

Configuration can be seen from Graph Page.
 - Program number,
 - Set values of segments
 - Segment counts
 - Segment length

MODBUS ERROR MESSAGES

Modbus protocol has two types error, communication error and operating error. Reason of the communication error is data corruption in transmission. Parity and CRC control should be done to prevent communication error. Receiver side checks parity and CRC of the data. If they are wrong, the message will be ignored. If format of the data is true but function doesn't perform for any reason, operating error occurs. Slave realizes error and sends error message. Most significant bit of function is changed '1' to indicate error in error message by slave. Error code is sent in data section. Master realizes error type via this message.

ModBus Error Codes

Error Code	Name	Meaning
01	ILLEGAL FUNCTION	The function code received in the query is not an allowable action for the slave. If a Poll Program Complete command was issued, this code indicates that no program function preceded it.
02	ILLEGAL DATA ADDRESS	The data address received in the query is not an allowable address for the slave.
03	ILLEGAL DATA VALUE	A value contained in the query data field is not an allowable value for the slave.

Message example;

Structure of command message (Byte Format)

Device Address	(0A)h
Function Code	(01)h
Beginning address of coils.	MSB (04)h
	LSB (A1)h
Number of coils (N)	MSB (00)h
	LSB (01)h
CRC DATA	LSB (AC)h
	MSB (63)h

Structure of response message (Byte Format)

Device Address	(0A)h
Function Code	(81)h
Error Code	(02)h
CRC DATA	LSB (B0)h
	MSB (53)h

Modbus Address Map

Holding Registers

EPC9513 PARAMETER LIST						
PARAMETER	INFORMATION	DATA TYPE	REG. ADDR.	MIN.	MAX.	DEF.
Input Type	0 = B type Termokupl 1 = E 2 = J 3 = K 4 = L 5 = N 6 = R 7 = S 8 = T 9 = U 10 = Pt100 11 = NTC 12 = 0-20 mA 13 = 4-20 mA 14 = 0-5 V 15 = 1-5 V 16 = 0-10 V 17 = 0-150 mV 18 = 0-550 Ohm 19 = 0-10 kOhm	Word	0	0	19	2
Scale Mnum	Can not be changed for Thermocouple and PT100 . Can be changed for Unversal Inputs. Scale Mnum s -100 for PT100 XXX.XX. Low lmt for Set Value parameter.	Word	1	-32768	32767	-1000
Scale Maxmum	Can not be changed for Thermocouple and PT100 . Can be changed for Unversal Inputs. Scale Maxmum s 160 for PT100 XXX.XX. Up lmt for Set Value parameter.	Word	2	-32768	32767	9000
Unt	0 = °C 1 = °F 2 = Bar 3 = %RH 4 = Hz 5 = A 6 = V .	Word	3	0	6	0
Input Offset	Offset added to Measurement.	Word	4	-99	99	0
Dgtal Filter Coeffcent	1 = Fastest response tme 32 = Slowest response tme Value of parameter should be increased n interference.	Word	5	1	32	4
Decmal Pont	0 = XXX 1 = XXX.X 2 = XXX.XX 3 = XXX.XXX . Accirdng to Decmal Pont parameter , modbus read/wrte data changed by 1,10,100,1000 lnearly.	Word	6	0	3	1
Mnum Set Value	Adjustable between Scale Mnum and Maxmum Set Value parameters.	Word	7	0	3	1
Maxmum Set Value	Adjustable between Scale Maksmum and Mnum Set Value parameters.	Word	8	0	3	1
Start - Stop Input	0=Dsable 1= Enable Profl Control start/stop dgtal nput dsable/enable.	Word	9	0	1	0
Pause - Resume Input	0= Dsable 1= Enable Profl Control pause/resume dgtal nput dsable/enable.	Word	10	0	1	0
Previous Program Input	0= Dsable 1= Enable Profl Control previous program dgtal nput dsable/enable.	Word	11	0	1	0
Next Program Input	0= Dsable 1= Enable Profl Control next program dgtal nput dsable/enable.	Word	12	0	1	0
Lnearzaton Table [0-31].Ponts	Lnearzaton table , value of ponts from 0 to 31.	Word	[13-44]	-32768	32767	0
Output Type	0 = Relay 1 = SSR 2 = 0-20 mA 3 = 4-20 mA 4 = 0-10 V 5 = Valve	Word	45	0	5	0
Re-Transmsson	0 = None 1 = 0-20 mA 2 = 4-20 mA 3 = 0-10 V	Word	46	0	3	0
Maxmum Analog Output Value		Word	47	0	100	100
Mnum Analog Output Value		Word	48	0	100	0
Output Hysteress	Adjustable between 1 and 50.	Word	49	0	50	0
Output Power Offset Around Set Pont(%)	Added offset(%) accordng to error around Set Value.	Word	50	0	100	0
Output Power Durng Prob Failure(%)	Ajustable between %0 and %100 , output wll cntnue n case of prob falure.	Word	51	0	100	0
Soft Start Tme(sec)	Adjustable between 0 and 200 seconds.	Word	52	0	200	10
SV Devaton	If (SV - PV > SV Devaton) at the end of the step and If SV Devaton s enabled , tme countdown wll be paused and control remans at last set value untl (SV - PV < SV Devaton) Please check parameter defnton on page 5.	Word	53	0	32767	0
Alarm 1 Set Value		Word	54	-32768	32767	1000
Alarm 2 Set Value		Word	55	-32768	32767	1000
Alarm 3 Set Value		Word	56	-32768	32767	1000
Alarm 1 Hysteress		Word	57	0	50	0
Alarm 1 Type	0 =Independent 1=Devaton 2=Band alarm 3=Band alarm wth nhbtaton 4=Profl control alarm	Word	58	0	4	0
Alarm 1 Up Lmt		Word	59	-32768	32767	9000
Alarm 1 Low Lmt		Word	60	-32768	32767	-1000
Alarm 2 Hysteress		Word	61	0	50	0
Alarm 2 Type	0 =Independent 1=Devaton 2=Band alarm 3=Band alarm wth nhbtaton 4=Profl control alarm	Word	62	0	4	0
Alarm 2 Up Lmt		Word	63	-32768	32767	9000
Alarm 2 Low Lmt		Word	64	-32768	32767	-1000
Alarm 3 Hysteress		Word	65	0	50	0
Alarm 3 Type	0 =Independent 1=Devaton 2=Band alarm 3=Band alarm wth nhbtaton	Word	66	0	3	0
Alarm 3 Up Lmt		Word	67	-32768	32767	9000
Alarm 3 Low Lmt		Word	68	-32768	32767	-1000
Proportional Band (%)	If t s set to %0.0 , ON-OFF control s actvated. If t s set to different from %0.0 , PID control s actvated. In order to read/wrte from modbus mutple/dvde wth 10. For example ; n order to set %5.5 , 5.5x10=55 must be wrten to parameter.	Word	69	0	100	4
Integral Tme (mn)	Adjustable between 0.0 and 100.0. If t s set to 0.0 , PD control s actvated. In order to read/wrte from modbus mutple/dvde wth 10. For example ; n order to set %5.5 , 5.5x10=55 must be wrten to parameter.	Word	70	0	100	4
Dervatve Tme (mn)	Adjustable between 0.0 and 25.0 If t s set to 0.0 , PI control s actvated. In order to read/wrte from modbus mutple/dvde wth 10. For example ; n order to set %5.5 , 5.5x10=55 must be wrten to parameter.	Word	71	0	25	1
Control Perod (sec)	Adjustable between 1 and 250 second.	Word	72	1	250	4
Start Program	Profle control's startng program number.	Word	73	1	16	1
Set Value		Word	74	-32768	32767	2000
Motorized Valve Position When Power On	When device is power on, it provides to motorized valve position.	Bit	75	0	0	1
Motorized Valve On/Off Time (sn)	It can set between 2-300 seconds.	Word	76	2	300	100
Motorized Valve Control Period(%)	Motorized valve configurations off time during on/off.This time gets by percent on/off time of motorized valve.	Word	77	1	50	25

Related to Decimal Point parameter; Scale Minimum , Scale Maximum , Linearization Table Points , Alarm 1 Set Value , Alarm 2 Set Value , Alarm 3 Set Value , Alarm 1 Up Limit , Alarm 1 Low Limit , Alarm 2 Up Limit , Alarm 2 Low Limit , Alarm 3 Up Limit , Alarm 3 Low Limit , Program Segment1 Set Value , Program Segment2 Set Value , Program Segment3 Set Value , Program Segment4 Set Value , Program Segment5 Set Value , Program Segment6 Set Value , Program Segment7 Set Value , Program Segment8 Set Value parameters are read/written linearly with 1,10,100,1000.

For example ; Decimal Point parameter is 1and If Set Value is 155.5 , Set Value will be read 1555 from modbus.

Profil Control Holding Registers

PARAMETER	INFORMATION	DATA TYPE	REG. ADR.	MIN.	MAX.	DEF.
Start Delay(mn.)	Delay before program startng.	Word	$1000 + (\text{ProgramNo}-1) \times 20$	0	180	0
Max. Step Count	Number of segments.	Word	$1000 + (\text{ProgramNo}-1) \times 20 + 1$	1	8	8
Repeat Count	Repeat count of program.	Word	$1000 + (\text{ProgramNo}-1) \times 20 + 2$	1	8	1
Next Program	Number of next program.	Word	$1000 + (\text{ProgramNo}-1) \times 20 + 3$	0	16	0
Program Segment1 Tme(mn.)	Program segment1's tme	Word	$1000 + (\text{ProgramNo}-1) \times 20 + 4$	0	32000	0
Program Segment1 Set Value	Program segment1's value	Word	$1000 + (\text{ProgramNo}-1) \times 20 + 5$	-32000	32000	0
Program Segment2 Tme(mn.)	Program segment2's tme	Word	$1000 + (\text{ProgramNo}-1) \times 20 + 6$	0	32000	0
Program Segment2 Set Value	Program segment2's value	Word	$1000 + (\text{ProgramNo}-1) \times 20 + 7$	-32000	32000	0
Program Segment3 Tme(mn.)	Program segment3's tme	Word	$1000 + (\text{ProgramNo}-1) \times 20 + 8$	0	32000	0
Program Segment3 Set Value	Program segment3's value	Word	$1000 + (\text{ProgramNo}-1) \times 20 + 9$	-32000	32000	0
Program Segment4 Tme(mn.)	Program segment4's tme	Word	$1000 + (\text{ProgramNo}-1) \times 20 + 10$	0	32000	0
Program Segment4 Set Value	Program segment4's value	Word	$1000 + (\text{ProgramNo}-1) \times 20 + 11$	-32000	32000	0
Program Segment5 Tme(mn.)	Program segment5's tme	Word	$1000 + (\text{ProgramNo}-1) \times 20 + 12$	0	32000	0
Program Segment5 Set Value	Program segment5's value	Word	$1000 + (\text{ProgramNo}-1) \times 20 + 13$	-32000	32000	0
Program Segment6 Tme(mn.)	Program segment6's tme	Word	$1000 + (\text{ProgramNo}-1) \times 20 + 14$	0	32000	0
Program Segment6 Set Value	Program segment6's value	Word	$1000 + (\text{ProgramNo}-1) \times 20 + 15$	-32000	32000	0
Program Segment7 Tme(mn.)	Program segment7's tme	Word	$1000 + (\text{ProgramNo}-1) \times 20 + 16$	0	32000	0
Program Segment7 Set Value	Program segment7's value	Word	$1000 + (\text{ProgramNo}-1) \times 20 + 17$	-32000	32000	0
Program Segment8 Tme(mn.)	Program segment8's tme	Word	$1000 + (\text{ProgramNo}-1) \times 20 + 18$	0	32000	0
Program Segment8 Set Value	Program segment8's value	Word	$1000 + (\text{ProgramNo}-1) \times 20 + 19$	-32000	32000	0

Profil control modbus addresses start from 1000.

In order to write/read profile program parameters to/from Modbus base address is $1000 + (\text{ProgramNo}-1) \times 20$.

Related to Decimal Point parameter Profil Control Set parameters are read/written linearly with 1,10,100,1000.

For example;

Program5 Start Delay (min.) Holding Register Address is $1000 + (5-1) \times 20 = 1080$

Program5 Setment6 Time (min.) Holding Register Address is $1000 + (5-1) \times 20 + 14 = 1094$

Input Registers

PARAMETER	INFORMATION	DATA TYPE	REG. ADR.	MIN.	MAX.	DEF.
Measured Value	Measured PV , result must be dvided by 10. For example; If temperature s 32.5 °C , 325 will be read over modbus.	Word	0	NONE	NONE	NONE
Internal NTC Temperature	Measured Internal NTC temperature , result must be dvided by 10. For example; If temperature s 32.5 °C , 325 will be read over modbus.	Word	1	NONE	NONE	NONE
Analog Output Percentage	Output % for 0-10V , 0-20mA or 4-20mA	Word	2	NONE	NONE	NONE
Current Program number	Runngng program number whle profile controller s runngng.	Word	3	NONE	NONE	NONE
Current segment number	Runngng segment number whle profile controller s runngng.	Word	4	NONE	NONE	NONE
Control Remannng Tme(mn)	Remannng tme of runngng program	Word	5	NONE	NONE	NONE

Coil Registers

PARAMETER	INFORMATION	DATA TYPE	REG. ADR.	MIN.	MAX.	DEF.
Use Lnearzaton Table	Dsable/Enable Lnearzaton table Can not be used for Thermocouple , PT100 and NTC . Can be used for Unversal Inputs.	Bt	0	0	1	0
Control Configuraton	0=ON-OFF COOLING 1=ON-OFF HEATING If Proportional Band parameter s %0 , ON-OFF control actvated.	Bt	1	0	1	1
Power Falure Behaviour	0= Stop 1= Resume If power falure occurs when profle control s runng and devce powered on after power falure; If stop s selected , profle control wll stop and turn to ntal state. If resume s selected , profle control wll resume from where t stopped.	Bt	2	0	1	0
Consstently Control	0 = OFF , profle control stops and turns to ntal state. 1 = ON , profle control contnue to control at last set value.	Bt	3	0	1	0
Sv Devaton Enable	0 = OFF , 1 = ON	Bt	4	0	1	0
Alarm 1 Status	0= LOW 1= HIGH	Bt	5	0	1	1
Alarm 1 Status Durng Prob Falure	0=OFF , alarm s nactive n case of prob falure. 1=ON , alarm s active n case of prob falure.	Bt	6	0	1	1
Alarm 2 Status	0= LOW 1= HIGH	Bt	7	0	1	1
Alarm 2 Status Durng Prob Falure	0=OFF , alarm s nactive n case of prob falure. 1=ON , alarm s active n case of prob falure.	Bt	8	0	1	1
Alarm 3 Status	0= LOW 1= HIGH	Bt	9	0	1	1
Alarm 3 Status Durng Prob Falure	0=OFF , alarm s nactive n case of prob falure. 1=ON , alarm s active n case of prob falure.	Bt	10	0	1	1
Auto Tune	0 = OFF 1 = ON , Improve PID parameters while selftune s runng. If PV s oscilating while profle control s runng , autotune wll mprove PID parameters n order to best control.	Bt	11	0	1	0
Snngle Set Pont	0 = OFF 1 = ON	Bt	12	0	1	0
Functon Col Start/Stop	Profle control can be started/stopped over modbus. If user wrte 1 to ths col , profle controller wll start/stop.	Bt	100	0	1	0
Functon Col Pause/Resume	Profle control can be paused/resumed over modbus. If user wrte 1 to ths col , profle controller wll pause/resume.	Bt	101	0	1	0
Functon Col Next	Profle control can start next program over modbus. If user wrte 1 to ths col , profle controller wll start to next program.	Bt	102	0	1	0
Functon Col Previous	Profle control can start previous program over modbus. If user wrte 1 to ths col , profle controller wll start to previous program.	Bt	103	0	1	0

Discrete Input Registers

PARAMETER	INFORMATION	DATA TYPE	REG. ADR.	MIN.	MAX.	DEF.
C/A3 Output Status	Control Relay / Alarm3 output state(0 = OFF , 1 = ON)	Bt	0	NONE	NONE	NONE
A1 Output Status	Alarm1 output state(0 = OFF , 1 = ON)	Bt	1	NONE	NONE	NONE
A2 Output Status	Alarm2 output state(0 = OFF , 1 = ON)	Bt	2	NONE	NONE	NONE
SSR Output Status	SSR output state(0 = OFF , 1 = ON)	Bt	3	NONE	NONE	NONE
Profle Controller Runng Status	Profle controller run state(0 = OFF , 1 = ON)	Bt	4	NONE	NONE	NONE
Profle Controller Pause Status	Profle controller pause state(0 = OFF , 1 = ON)	Bt	5	NONE	NONE	NONE
Prob Falure Status	Prob falure(0 = OFF , 1 = ON)	Bt	6	NONE	NONE	NONE