



Read this document carefully before using this device. The guarantee will be expired by device damages if you don't attend to the directions in the user manual. Also we don't accept any compensations for personal injury, material damage or capital disadvantages.

# ENDA ECH SERIES UP/DOWN COUNTER & RPM/TACHOMETER

Thank you for choosing ENDA ECH series devices.

- ▶ 48x48mm and 72x72mm sizes.
- ▶ 2x6 digits indicator.
- ▶ Programmable as Counter and RPM/Tachometer.
- ▶ 6 Digits Batch Counter.
- ▶ 9 Digits Total Counter.
- ▶ Period time differences, pulse time, turnover and speed measurement.
- ▶ Easy to use front panel keypad.
- ▶ Counts Up or Down according to input phase difference.
- ▶ Input frequency can be selected.
- ▶ Input signal can be calibrated to the desired value by multiplying between 0.000001 and 99.9999.
- ▶ Decimal point can be set between 1 and 5.
- ▶ Sensor input type can be selected by using keypad ( PNP, NPN ).
- ▶ Dual setpoint and dual contact relay.
- ▶ SET1 can be selected to dependent on SET2.
- ▶ Output contact relay can be adjusted to continuous output or between 0.01 and 999.9-second intervals.
- ▶ Output delay time can be adjusted in Tachometer Mode.
- ▶ Functional reset selection.
- ▶ 0 - 500000 Offset selection.
- ▶ Parameter access protection.
- ▶ Easy installation.
- ▶ RS485 Modbus communication interface (Specify at order).
- ▶ CE marked according to European Norms.



Order Code : ECH <input type="text"/> <input type="text"/> 0 0 - <input type="text"/> - <input type="text"/>		
1	2	3
<b>1 - Size</b> 4400.....48x48x87mm 7700.....72x72x97mm	<b>2 - Supply Voltage</b> UV.....90-250V AC  LV.....10-30V DC / 8-24V AC	<b>3 - Modbus</b> RS ...Modbus (Specify at Order)



**RoHS**  
Compliant

## TECHNICAL SPECIFICATIONS

### ENVIRONMENTAL CONDITIONS

<b>Ambient / Storage Temperature</b>	0 ... +50°C/-25 ... +70°C (with no icing)
<b>Max. relative humidity</b>	80% Relative humidity for temperatures up to 31°C, decreasing linearly to 50% at 40°C.
<b>Rated pollution degree</b>	According to EN 60529 ; Front Panel : IP65, Rear Panel : IP20
<b>Height</b>	Max. 2000m

**⚠ KEEP AWAY device from exposed to corrosive, volatile and flammable gases or liquids and DO NOT USE the device in similar hazardous locations.**

### ELECTRICAL CHARACTERISTICS

<b>Supply</b>	90-250V AC 50/60Hz ; 10-30V DC / 8-24V AC SMPS
<b>Power Consumption</b>	Max. 5VA
<b>Wiring</b>	Power connection : 2.5mm <sup>2</sup> screw-terminal, Signal connection : 1,5mm <sup>2</sup> screw-terminal connections
<b>Data Protection</b>	EEPROM (Min. 10 years)
<b>EMC</b>	EN 61326-1: 2013 (Performance criterion B satisfied for EN 61000-4-3 standard).
<b>Safety Requirements</b>	EN 61010-1: 2010

### INPUTS

<b>Count inputs CPA, CPB</b>	2 Channels (Max. 50KHz, between 5V and 30V pulses). Can be selected as PNP and NPN input.
<b>Counting frequency (Hz)</b>	Can be programmed to 20hz, 50hz, 100Hz,500hz, 1000hz, 5000hz, 10KHz,20KHz, 30KHz and 40KHz.
<b>Reset Input</b>	PNP : Positive Reset (Can be adjusted between 1ms and 100ms for 5V and 30V pulses). NPN : GND terminal can be reset by connecting to "RESET IN" terminal.

### OUTPUTS

<b>Control Output (OUT1 and OUT2)</b>	ECH4400 : OUT1 250V AC, 10A (for resistive load) NO+NC , OUT2 250V AC , 5A(for resistive load) NO ECH7700 : OUT1 250V AC, 8A (for resistive load) NO+NC
<b>SSR1 and SSR2 Output</b>	Open collector output (S.S. OUT) : Max. 30V DC, 50mA
<b>Sensor (Auxiliary) Supply Output</b>	12V DC, Max. 50mA (without regulation)
<b>Life expectancy for relay</b>	Without load 5.000.000 switching; 250V AC, 5A (resistive load) 100.000 switching. Without load 30.000.000 switching; 250V AC, 8A (resistive load) 300.000 switching. Without load 30.000.000 switching; 250V AC, 10A (resistive load) 100.000 switching.
<b>Accuracy</b>	± % 0.01 ± 1ms

**⚠ Note : "Relay" and "S.S.OUT" outputs runs simultaneously. i.e, When "OUT1" or "OUT2" relay is operated, "SSR1" or "SSR2" transistor is activated.**

### HOUSING

<b>Housing Type</b>	Suitable for flush-panel mounting according to DIN 43 700.
<b>Dimensions</b>	ECH4400 : G48xY48xD87mm, ECH7700 : G72xY72xD97mm.
<b>Weight</b>	ECH4400 : Approx. 230g (after packing) ECH7700 : Approx. 380g (after packing)
<b>Enclosure Material</b>	Self extinguishing plastics

**⚠ Avoid any liquid contact when the device is switched on. DO NOT clean the device with solvent (thinner, gasoline, acid etc.) and / or abrasive cleaning agents.**



SISEL MÜHENDİSLİK ELEKTRONİK SAN. VE TİC. A.Ş.  
Şenifali Mah. Barbaros Cad. No:18 Y.Dudullu 34775  
ÜMRANİYE/İSTANBUL-TÜRKİYE  
Tel : +90 216 499 46 64 Pbx. Fax : +90 216 365 74 01  
url : www.enda.com.tr

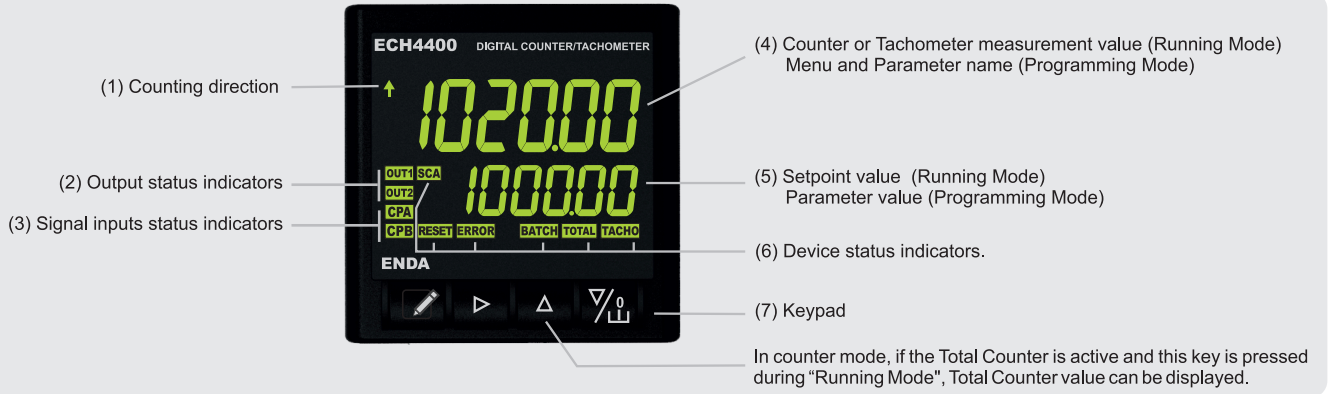

(1) Counting Direction	Up / Down arrows (same as PV indicator color)
(2) Output status indicators	Two pieces (same as SV indicator color)
(3) Signal inputs indicators	Two pieces (same as SV indicator color)
(4) PV Indicators	7 segment, 6 digits. LCD indicator colors can be selected as red, green and orange. (Character height 10 mm).
(5) PV Indicators	7 segment, 6 digits. LCD indicator colors can be selected as red, green and orange. (Character height 7 mm).
(6) Device status indicators	Six pieces (same as SV indicator color)
(7) Keypad	Micro switch

### SETTING UP PRESET VALUES

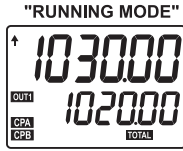

While in "Running Mode", by pressing to key, **Preset1** or **Preset2** setpoint values can be selected. Selected setpoint value displayed on the upper indicator and adjustable digit flashes. If no key is pressed for 4 seconds, "Running Mode" is entered.

#### PRESSED VALUES



By using key, **Preset1** time is selected and by pressing key desired digit is selected. Selected digit flashes and by using keys desired value adjusted.

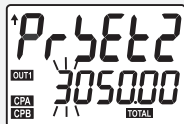

For **Preset2**, Same method is applied such as **Preset1** value settings.



If **TACHO** mode is selected and the **INPTYP** parameter is set to **IR-ib** or **IR.ib.rR**, CPA input can be monitored at the bottom display.



If **TACHO** mode is selected and the **INPTYP** parameter is set to **IR-ib** or **IR.ib.rR**, CPB input can be monitored at the bottom display.

## COUNTER SETTINGS

⚠ If *dEnodE* parameter is selected as *Counter*, following parameters will be activated.

### Accessing to "Running Mode" from "Programming Mode" :

if no key is pressed within 20 seconds, during "Programming Mode", data is stored automatically and "Running Mode" is entered. Alternatively, the same function occurs first pressing **▶** key and "Programming Mode" is entered. Then **◀** **▶** keys are pressing together, data is recorded and "Running Mode" is entered.

If **◀** key is pressed while holding **▶** key, "Programming Mode" is entered.

#### Input Configuration Menu

**inpCnf**

**inpTYP**  
RuPbuP  
Input Type Selection  
7 different counting types can be selected for *CPA* and *CPb* inputs. (See TABLE.3 for options)

**CntDir**  
uP-Cnt  
Counting Direction  
Counter Up / Down selection.

**inPCAL**  
100000  
Calibration Multiplier  
Can be adjusted between 0.000001 and 99.9999 Counter value multiplied by the calibration value.

**inPFrq**  
10h  
Maximum Frequency Selection  
Allows to set the maximum count frequency can be applied to counter input. 10 different slices frequencies can be

**SEntYP**  
nPn  
Sensor Type Selection  
Can be selected as *nPN* or *PnP*. *PnP* must be selected for Encoder.

**reSPLS**  
100ns  
Reset Input Puls Time  
Required minimum pulse duration for reset input. Can be adjusted to 1, 5, 10, 20 and 50msec.

#### Output Configuration Menu

**outCnf**

**outTYP**  
tYP1  
Output Type Selection  
10 different output types can be selected. (See TABLE.4 for selections)

**out1in**  
Hold  
Out1 Output Duration  
Can be adjusted between 0.0 and 999.9 seconds. If 0.0 is selected, output is energized continuously when Preset1 value is reached.

**out2in**  
Hold  
Out2 Output Duration  
Can be adjusted between 0.0 and 999.9 seconds. If 0.0 is selected, output is energized continuously when Preset2 value is reached.

**totCnf**  
d5AbL  
Total Counter Settings  
*d5AbL* = Total Counter is disabled. If *Counter* is selected, Total Counter input is connected to the counter inputs. If *out1* is selected, out1 counted from Total Counter. If *out2* is selected, out2 counted from Total Counter. Note : If one of the Total Counter mode is selected and **▶** key is pressed during "Running Mode", Total Counter value can be displayed.

**Pr5Cnf**  
Pr5Et1  
Out1 Setpoint Value Selection  
If *Pr5Et1* is selected, when counter value is equal to the Preset1 value, Out1 output is activated. If *Pr2-P1* is selected, Preset2 counter value is subtracting by Preset1 and Out1 output is activated during equal to the value.

#### Indicator Configuration Menu

**d5PCnf**

**dEcPo**  
0  
Decimal Point Selection  
Can be put point between 0 and 0.00000

**off5Et**  
0  
Reset Offset Selection  
Can be adjusted between 0 and 5 000 000. When the counter is reset, the timer starts from the offset value.

**d5Pnod**  
[-5.1  
Counter Display Type Selection  
Sets the selection for the desired parameters from indicating on top and bottom display. (See TABLE.2 for selections)

**d5Pbr1**  
10  
Display Brightness Selection  
Can be display brightness adjusted between 1 and 20.

#### Device Configuration Menu

**dCONF**

**dEnodE**  
Counter  
Device Mode Configuration  
The device mode type can be selected as a Tachometer or Counter, Menu parameters may be changed by the depends on the selected mode (See page 5/7).

**Pr5tCF**  
d5AbL  
Panel Reset Configuration  
Can be 8 different setting. (See TABLE.1)

**ir5tCF**  
d5AbL  
Reset Input Configuration  
Can be 8 different setting. (See TABLE.1)

**CPoff5**  
no  
Counter Value Storage Configuration  
If yes select; when the energy is cut, counter and exit status is stored. If no select; when the energy is cut, counter and exit status is not stored.

**dEADR**  
i  
Device Address  
Communication address for ModBus devices. Can be adjustable between 1 and 247.

**BRudrR**  
9600  
Rs485 Communication Speed  
If oFF is selected ModBus communication disable. Can be adjusted 2400, 4800, 9600, 19200 and 38400 baudrate values.

#### Security Configuration Menu

**SECnf**

**SECuCd**  
0  
Security Menu Password  
For accessing this menu, this parameter must be entered. Security code is 4400.

**inP5Ec**  
PYE5  
Input Menu Security Level  
If *nonE* Menu invisible. If *PYE5* Modification can be done. If *P.no* Only visible.

**out5Ec**  
PYE5  
Output Menu Security Level  
If *nonE* Menu invisible. If *PYE5* Modification can be done. If *P.no* Only visible.

**d5P5Ec**  
PYE5  
Indicator Menu Security Level  
If *nonE* Menu invisible. If *PYE5* Modification can be done. If *P.no* Only visible.

**dCn5Ec**  
PYE5  
Device Menu Security Level  
If *nonE* Menu invisible. If *PYE5* Modification can be done. If *P.no* Only visible.

**Pr15Ec**  
PYE5  
Preset1 Parameter Security Menu Level  
If *PYE5* Modification can be done. If *P.no* Only visible.

**Pr25Ec**  
PYE5  
Preset2 Parameter Security Level  
If *PYE5* Modification can be done. If *P.no* Only visible.

TABLE.1

Reset Configuration Table:

Parameter Message	Parameter Message	action to be taken
0	d5AbL	Reset is not done
1	C-r	Counter Reset On
2	t-r	Total Reset On
3	b-r	Batch Reset On
4	Ct-r	Counter and Total Reset On
5	Cb-r	Counter and Batch Reset On
6	tb-r	Total and Batch Reset On
7	Ctb-r	Counter, Total and Batch Reset On

TABLE.2

Parameter selection table

d5Pnod"R value	Parameter Message	UPPER Display	Lower Display
0	C-5.1	Counter	SET1
1	C-5.2	Counter	SET2
2	C-b	Counter	Batch
3	b-5.1	Batch	SET1
4	b-5.2	Batch	SET2
5	th-tL	Total H	Total L

**Attention !!**  
 \* If Batch counter mode is not selected, mode 2, mode 3 and mode 4 can not be selected  
 \* If the Total Counter is disabled, mode 5 can not be selected.  
 \* If one of the Total Counter mode is selected and mode 5 is not selected, by pressing **▶** key during "Running Mode", Total Counter value can be displayed.  
 \* While Total Counter displayed, by pressing **▼** key, Total Counter value can be reset.

#### PARAMETER SETTINGS

inPCAL 100000 **◀** inPCAL 100-dP **▶** inPCAL 100-dP **▼** inPCAL 100-dP **▶** inPCAL 100000 **▶** inPCAL 200000 **▶** inPCAL 100000

The selected parameter of the digit will flash when the **◀** key is pressed. Value can be changed by using **▶** **▼** navigation keys. The next digit can be selected with the **▶** key and the same method can be applied as the previous step. If the decimal point of the selected parameter can also be adjusted, the message -dP appears on the display during the digit selection. While this message is displayed, the decimal point is brought to the desired place with the **▶** **▼** keys.

If the **▶** key (Up) is pressed continuously for 0.6 seconds, the value to be increasing rapidly. The same method applies to the decrement (Down) key.

TABLE.3

COUNTER INPUT TYPE TABLE

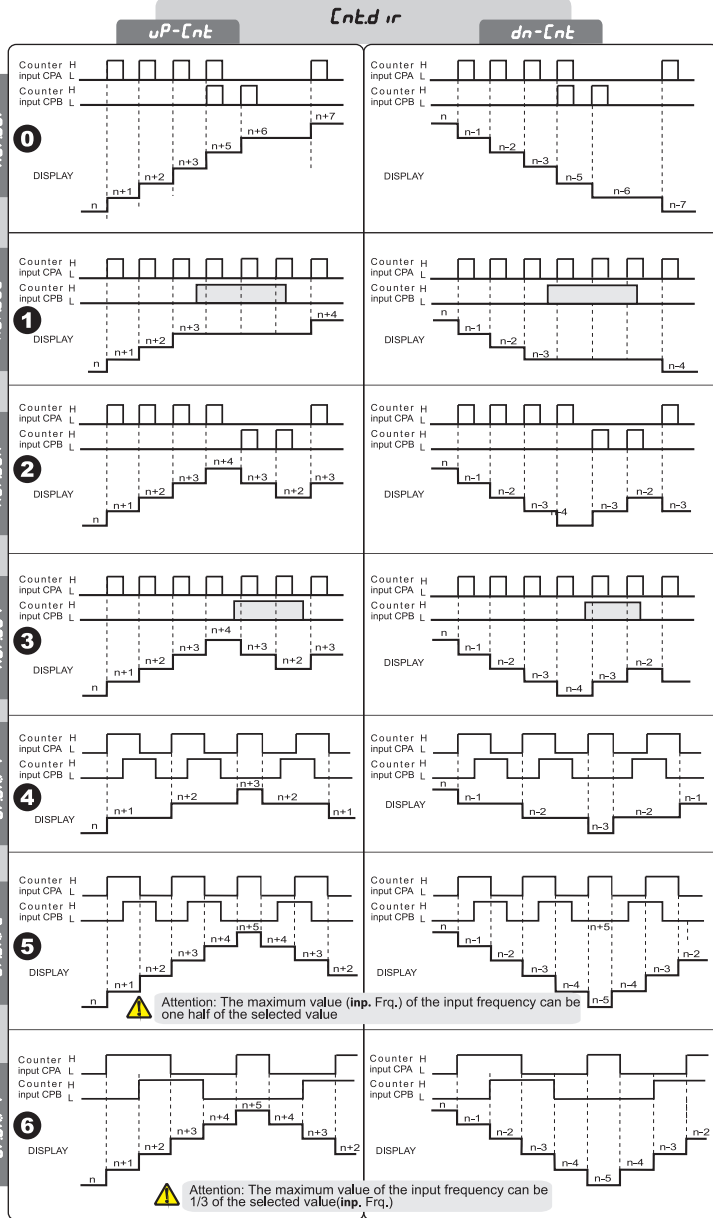

NOTE: 1

INPUT TYPE

Input Symbol	NPN input (Voltage input no)	PNP input (Voltage input)
H	input short circuit	4,5V - 30V DC
L	input open circuited	0V - 2V DC



Input frequency must not exceed the specified value. If input frequency exceed the specified value, the device does not make accurate count.

TABLE.4

COUNTER OUT TYPE TABLE

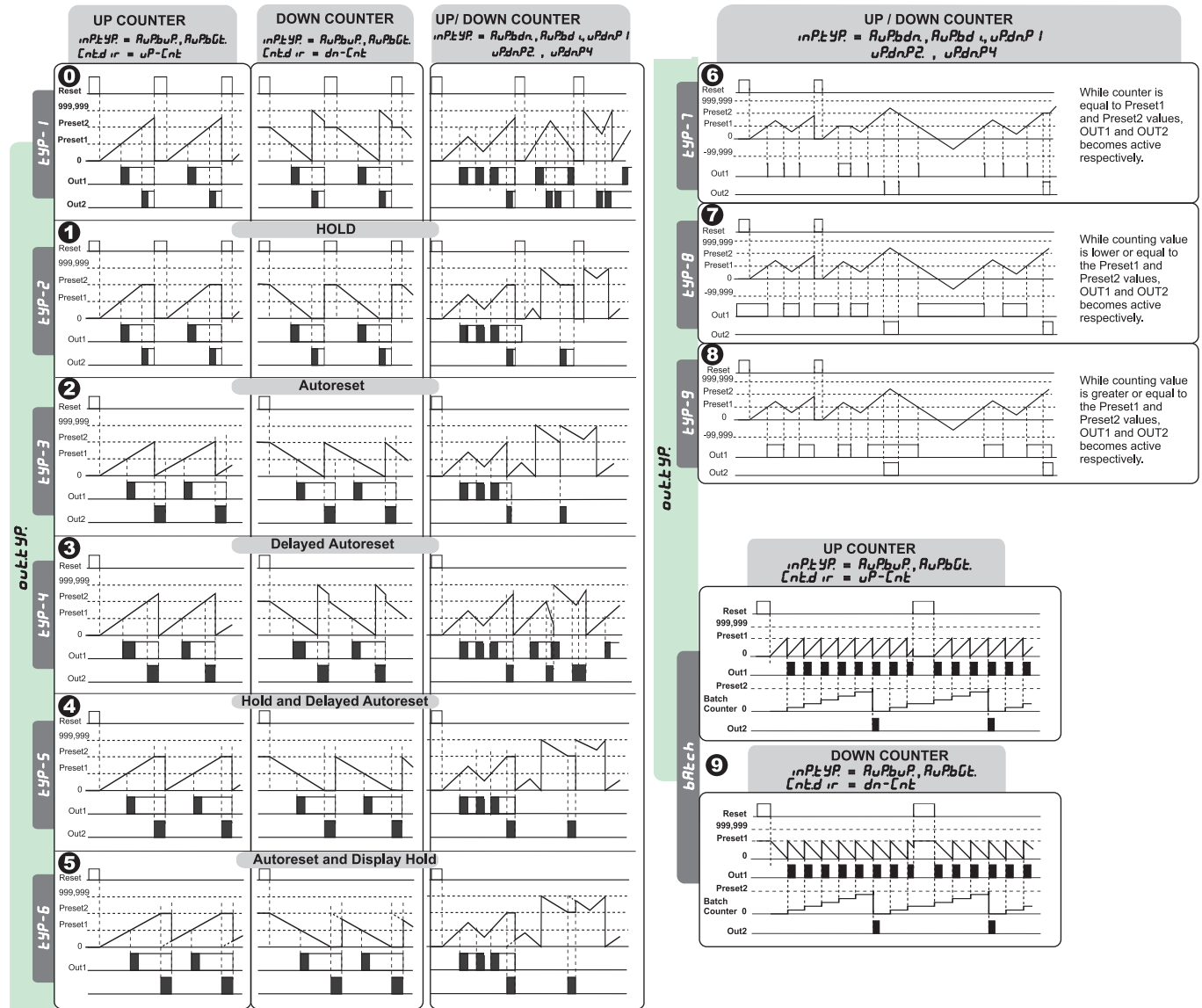

While  $batch$  counter mode is selected, decimal point is invisible.

Because,  $PrsEt2$  and  $batch$  values are integer.

■ If  $ou\ tE\ i\ n$  and  $ou\ tE\ i\ n$  is adjusted between 0.01 and 999.9 sec, pulse output is obtained

□ If  $ou\ tE\ i\ n$  and  $ou\ tE\ i\ n$  is adjusted between 0,0 and 999,9 sec, continuous output is obtained.





# REV/SPEED MEASURING MODE PROGRAMMING DIAGRAM

**⚠ If  $dE\dot{n}odE$  parameter is selected as  $tRcho$ , following parameters will be activated.**

If **[Enter]** key is pressed while holding **[Right]** key, "Programming Mode" is entered.

Accessing to "Running Mode" from "Programming Mode":

if no key is pressed within 20 seconds, during "Programming Mode", data is stored automatically and "Running Mode" is entered. Alternatively, the same function occurs first pressing **[Right]** key and "Programming Mode" is entered. Then **[Enter]** **[Right]** keys are pressing together, data is recorded and "Running Mode" is entered.

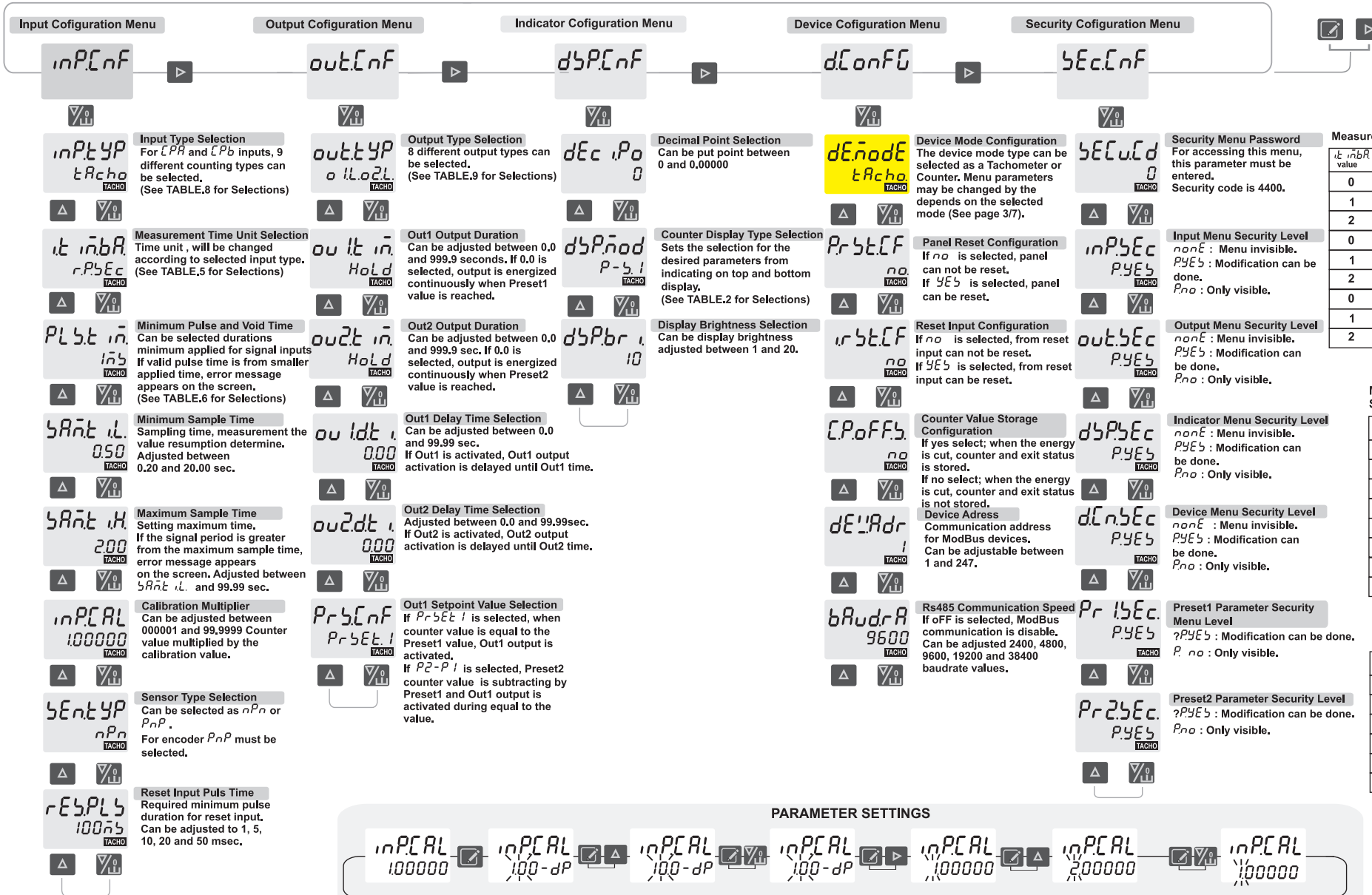

**TABLE.5**  
Measurement Time Unit Selection Table

$t\dot{n}BR$ value	Parameter message	Explanation	$inP5Ec$
0	$rP5Ec$	Puls in 1 second	$tRcho$
1	$rP\dot{n}in$	Puls in 1 minute	$t\dot{i}2rA$
2	$rPhour$	Puls in 1 hour	$t\dot{i}2$
0	$\dot{n}P5Ec$	meter / second	
1	$\dot{n}P\dot{n}in$	meter / minute	$L\dot{n}5Pd$
2	$\dot{n}Phour$	metre / hour	
0	$\dot{n}ic5Ec$	microseconds	$PEr\dot{i}od$
1	$\dot{n}l5Ec$	milliseconds	$t\dot{i}\dot{n}in\dot{t}$
2	$100\dot{n}5$	100 milliseconds	$PL5t\dot{i}n$

**TABLE.6**  
Minimum Pulse Void Time Selection Table

$PL5t\dot{i}n$ value	Parameter message	Explanation
0	$40\dot{n}5$	40 msec
1	$20\dot{n}5$	20 msec
2	$10\dot{n}5$	10 msec
3	$1\dot{n}5$	1 msec
4	$05\dot{n}5$	0,5 msec
5	$0.1\dot{n}5$	0,1 msec
6	$005\dot{n}5$	0,05 msec
7	$002\dot{n}5$	0,01 msec

**TABLE.7**  
Parameter Selection Table to Display



$dsP\dot{n}od$ value	Parameter message	UPPER Display	LOWER Display
0	$P-5.1$	Measuring	SET1
1	$P-5.2$	Measuring	SET2
2	$P-R5.1$	Measuring	On SET1
3	$P-tP$	Measuring	Total Rev
4			
5			







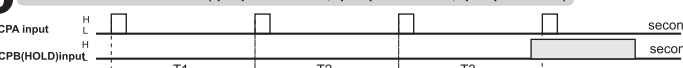
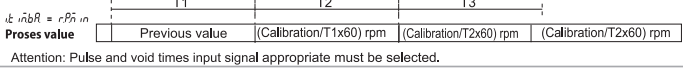
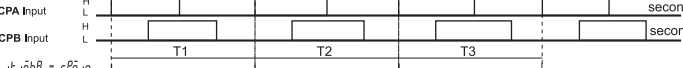
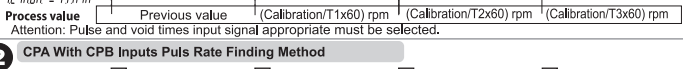
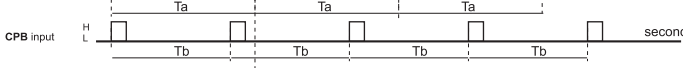
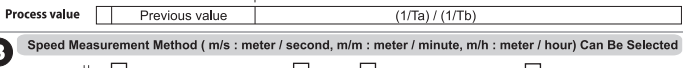
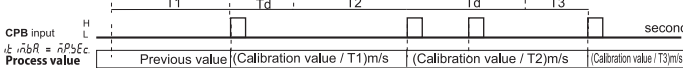
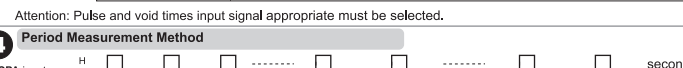
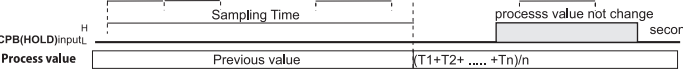
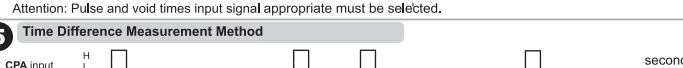
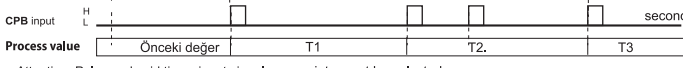
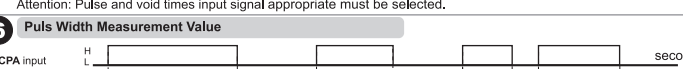
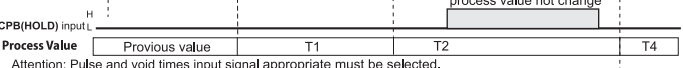
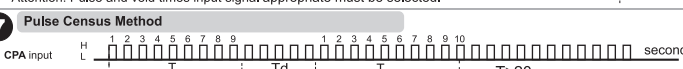
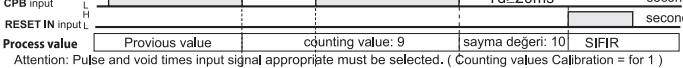
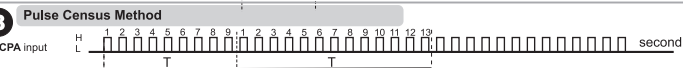
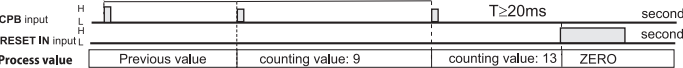
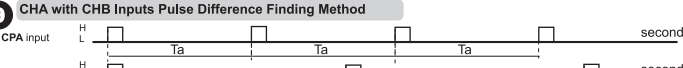
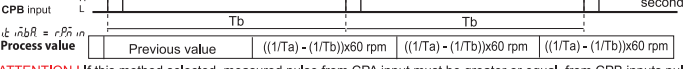
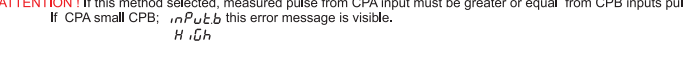

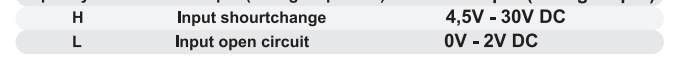
The selected parameter of the digit will flash when the **[Enter]** key is pressed. Value can be changed by using **[Up]** **[Down]** navigation keys. The next digit can be selected with the **[Right]** key and the same method can be applied as the previous step. If the decimal point of the selected parameter can also be adjusted, the message  $-dP$  appears on the display during the digit selection. While this message is displayed, the decimal point is brought to the desired place with the **[Up]** **[Down]** keys. If the **[Up]** key (Up) is pressed continuously for 0.6 seconds, the value to be increasing rapidly. The same method applies to the decrement (Down) key.

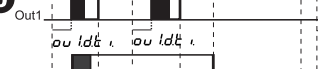
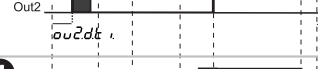
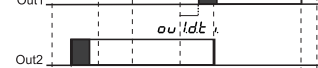
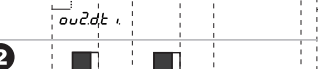
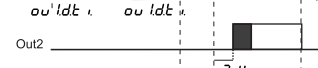
**TABLE.8 PULSE MEASUREMENT INPUT TYPE TABLE**

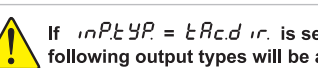
**TABLE.9 PULSE MEASURED OUTPUTS TYPE TABLE**

<p><b>0</b> Pulse Measurement Method (rps: pulse/second, rpm: pulse/minute, rph : pulse/hour)</p> <p>CPA input  second</p> <p>CPB(HOLD)input  second</p> <p>Process value <math>\dot{e} \dot{n} \dot{b} \dot{R} = r \dot{P} \dot{n} \dot{m}</math> Previous value (Calibration/T1x60) rpm (Calibration/T2x60) rpm (Calibration/T3x60) rpm</p> <p>Attention: Pulse and void times input signal appropriate must be selected.</p>	<p><b>1</b> Phase Difference Input Pulse Measurement Method (rps: pulse/second, rpm: pulse/minute, rph : pulse/hour) Direction Indicator</p> <p>CPA Input  second</p> <p>CPB Input  second</p> <p>Process value <math>\dot{e} \dot{n} \dot{b} \dot{R} = r \dot{P} \dot{n} \dot{m}</math> Previous value (Calibration/T1x60) rpm (Calibration/T2x60) rpm (Calibration/T3x60) rpm</p> <p>Attention: Pulse and void times input signal appropriate must be selected.</p>	<p><b>2</b> CPA With CPB Inputs Puls Rate Finding Method</p> <p>CPA input  second</p> <p>CPB input  second</p> <p>Process value Previous value <math>(1/Ta) / (1/Tb)</math></p>	<p><b>3</b> Speed Measurement Method ( m/s : meter / second, m/m : meter / minute, m/h : meter / hour) Can Be Selected</p> <p>CPA input  second</p> <p>CPB input  second</p> <p>Process value Previous value (Calibration value / T1)m/s (Calibration value / T2)m/s (Calibration value / T3)m/s</p> <p>Attention: Pulse and void times input signal appropriate must be selected.</p>	<p><b>4</b> Period Measurement Method</p> <p>CPA input  second</p> <p>CPB(HOLD)input  second</p> <p>Process value Previous value <math>(T1+T2+ \dots +Tn)/n</math></p> <p>Attention: Pulse and void times input signal appropriate must be selected.</p>	<p><b>5</b> Time Difference Measurement Method</p> <p>CPA input  second</p> <p>CPB input  second</p> <p>Process value Önceki değer T1 T2 T3</p> <p>Attention: Pulse and void times input signal appropriate must be selected.</p>	<p><b>6</b> Puls Width Measurement Value</p> <p>CPA input  second</p> <p>CPB(HOLD) input  second</p> <p>Process Value Previous value T1 T2 T4</p> <p>Attention: Pulse and void times input signal appropriate must be selected.</p>	<p><b>7</b> Pulse Census Method</p> <p>CPA input  second</p> <p>CPB input  second</p> <p>RESET IN input  second</p> <p>Process value Previous value counting value: 9 sayma değeri: 10 SIFIR</p> <p>Attention: Pulse and void times input signal appropriate must be selected. ( Counting values Calibration = for 1 )</p>	<p><b>8</b> Pulse Census Method</p> <p>CPA input  second</p> <p>CPB input  second</p> <p>RESET IN input  second</p> <p>Process value Previous value counting value: 9 counting value: 13 ZERO</p> <p>Attention: Pulse and void times input signal appropriate must be selected. ( Counting values Calibration = for 1 )</p>	<p><b>9</b> CHA with CHB Inputs Pulse Difference Finding Method</p> <p>CPA input  second</p> <p>CPB input  second</p> <p>Process value Previous value <math>((1/Ta) - (1/Tb)) \times 60</math> rpm <math>((1/Ta) - (1/Tb)) \times 60</math> rpm <math>((1/Ta) - (1/Tb)) \times 60</math> rpm</p> <p><b>ATTENTION!</b> If this method selected, measured pulse from CPA input must be greater or equal to CPA from CPB inputs pulse. If CPA small CPB; <math>\dot{n} \dot{P} \dot{u} \dot{b}</math> this error message is visible. <math>H, \dot{I} \dot{h}</math></p>
---	---	---	--	--	--	---	---	--	---

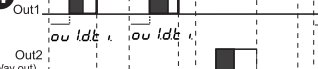
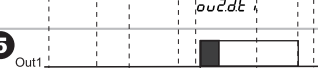
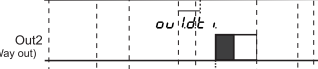
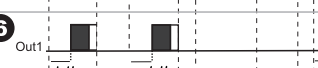
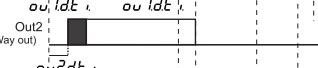
<p><b>0</b></p> <p>Out1  <math>ou \dot{l} \dot{d} \dot{t} \dot{i}</math></p> <p>Out2  <math>ou \dot{z} \dot{d} \dot{t} \dot{i}</math></p>	<p><b>1</b></p> <p>Out1  <math>ou \dot{l} \dot{d} \dot{t} \dot{i}</math></p> <p>Out2  <math>ou \dot{z} \dot{d} \dot{t} \dot{i}</math></p>	<p><b>2</b></p> <p>Out1  <math>ou \dot{l} \dot{d} \dot{t} \dot{i}</math></p> <p>Out2  <math>ou \dot{z} \dot{d} \dot{t} \dot{i}</math></p>	<p><b>3</b></p> <p>Out1  <math>ou \dot{l} \dot{d} \dot{t} \dot{i}</math></p> <p>Out2  <math>ou \dot{z} \dot{d} \dot{t} \dot{i}</math></p>	<p><b>4</b></p> <p>Out1  <math>ou \dot{l} \dot{d} \dot{t} \dot{i}</math></p> <p>Out2 (Way out)  <math>ou \dot{z} \dot{d} \dot{t} \dot{i}</math></p>	<p><b>5</b></p> <p>Out1  <math>ou \dot{l} \dot{d} \dot{t} \dot{i}</math></p> <p>Out2 (Way out)  <math>ou \dot{z} \dot{d} \dot{t} \dot{i}</math></p>	<p><b>6</b></p> <p>Out1  <math>ou \dot{l} \dot{d} \dot{t} \dot{i}</math></p> <p>Out2 (Way out)  <math>ou \dot{z} \dot{d} \dot{t} \dot{i}</math></p>	<p><b>7</b></p> <p>Out1  <math>ou \dot{l} \dot{d} \dot{t} \dot{i}</math></p> <p>Out2 (Way out)  <math>ou \dot{z} \dot{d} \dot{t} \dot{i}</math></p>
---	---	---	---	--	---	---	---

**!** If  $\dot{n} \dot{P} \dot{u} \dot{b}$  =  $\dot{t} \dot{R} \dot{c} \dot{d} \dot{i} \dot{r}$ . is selected, following output types will be activated.

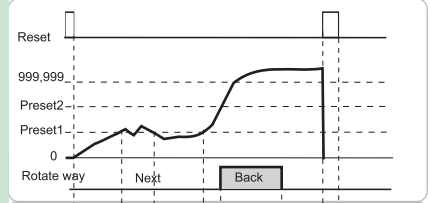

■ If  $ou \dot{l} \dot{d} \dot{t} \dot{i}$  and  $ou \dot{z} \dot{d} \dot{t} \dot{i}$  is adjusted between 0.01 and 999.9 sec. pulse output is obtained.

□ If  $ou \dot{l} \dot{d} \dot{t} \dot{i}$  and  $ou \dot{z} \dot{d} \dot{t} \dot{i}$  is adjusted between 0.0 sec. (Hold) continuous output is obtained.

$ou \dot{l} \dot{d} \dot{t} \dot{i}$  and  $ou \dot{z} \dot{d} \dot{t} \dot{i}$  is adjusted between 0.0 and 999.9 sec. Output delayed of until adjusted time . When set 0 output is instantly taken

NOTE: 1

	INPUT TYPE	
Input Symbol	NPN input (Voltage input not)	PNP input (Voltage input)
H	Input shourchange	4,5V - 30V DC
L	Input open circuit	0V - 2V DC

# CONNECTION DIAGRAM

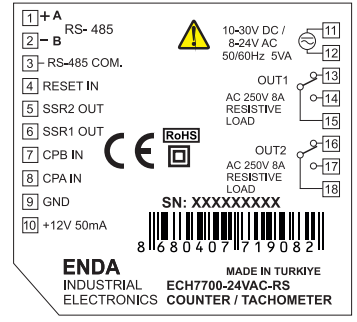
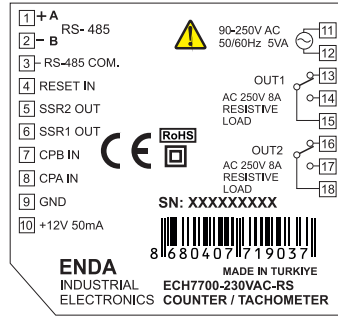
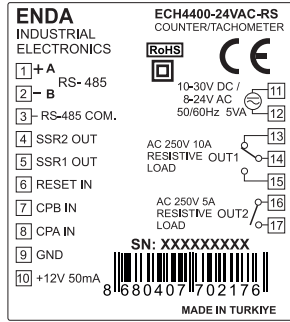
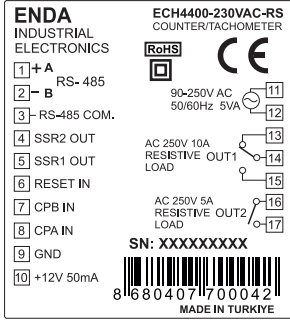

## SENSOR CONNECTION SAMPLES

### Connection samples for PNP sensor type

### Connection samples for NPN sensor type

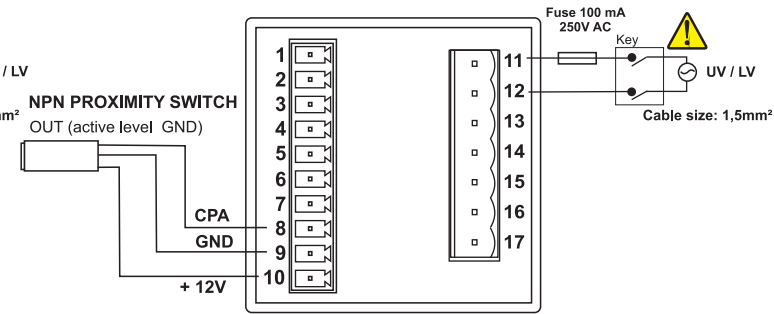
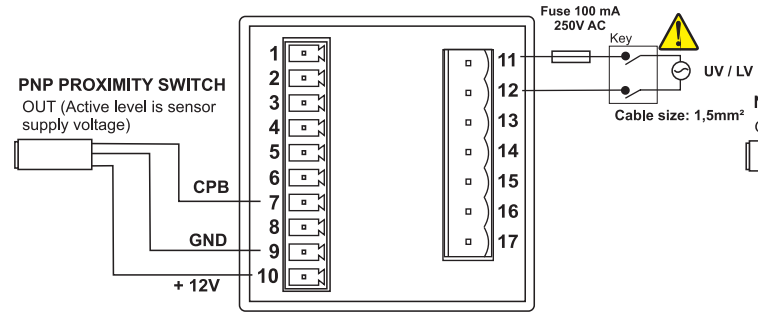
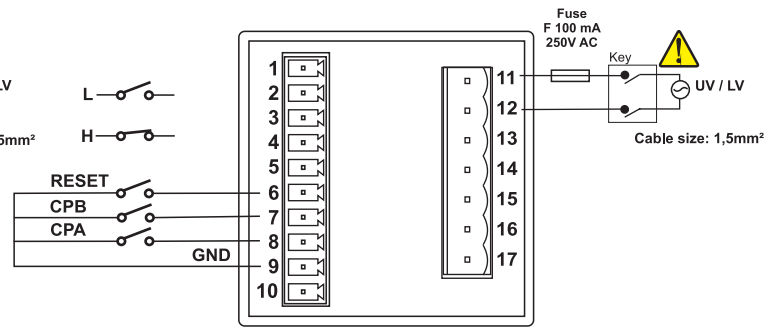
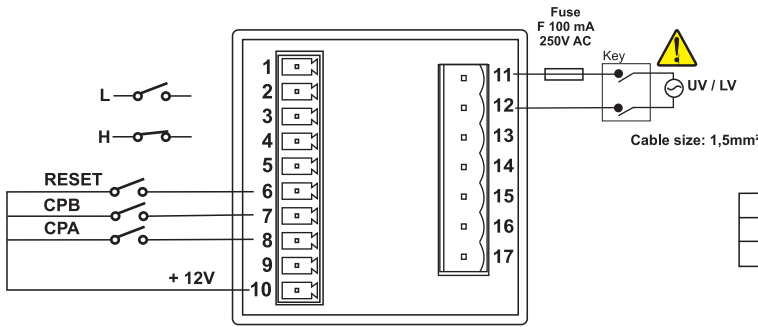

**!** Logic output of the device is not electrically isolated.

- Note :**
- 1) Mains supply cords shall meet the requirements of IEC60227 or IEC60245.
  - 2) In accordance with the safety regulations, the power supply switch shall bring the identification of the relevant instrument and it should be easily accessible by the operator.

Holding screw 0,4-0,5Nm

Equipment is protected throughout by DOUBLE INSULATION.

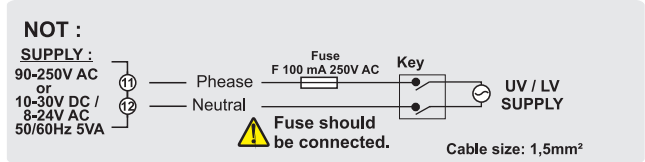

# DIMENSIONS

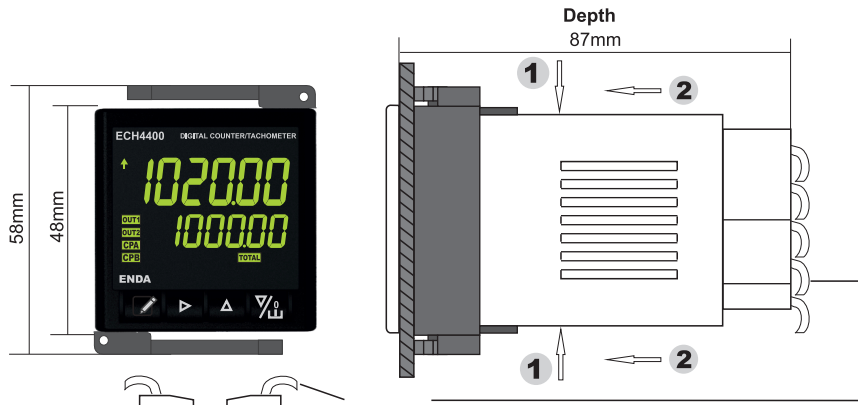

**To removing the device from the panel:**  
 - While pressing both side of the device in direction **1** and push it in direction **2** .

**NOTE:**

- 1) While performing panel mounting, additional space should be allocated for cables.
- 2) Panel thickness should be maximum **9mm**.
- 3) If there is no **100mm** free space at back side of the device, it would be difficult to remove it from the panel.

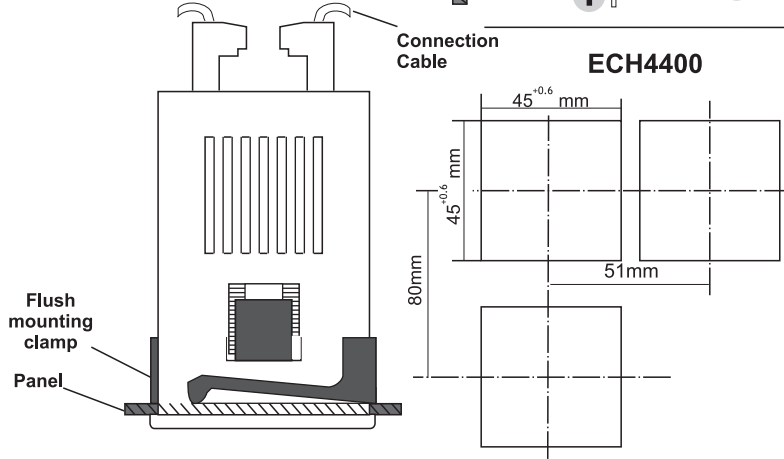

**ENDA ECH Series** are intended for installation within control panels. Make sure that the device is used only for intended purpose. The shielding must be grounded on the instrument side. During an installation, all of the cables that are connected to the device must be free of electrical power. The device must be protected against inadmissible humidity, vibrations, severe soiling. Make sure that the operation temperature is not exceeded. All input and output lines that are not connected to the supply network must be laid out as shielded and twisted cables. These cables should not be close to the power cables or components. The installation and electrical connections must be carried out by a qualified staff and must be according to the relevant locally applicable regulations.

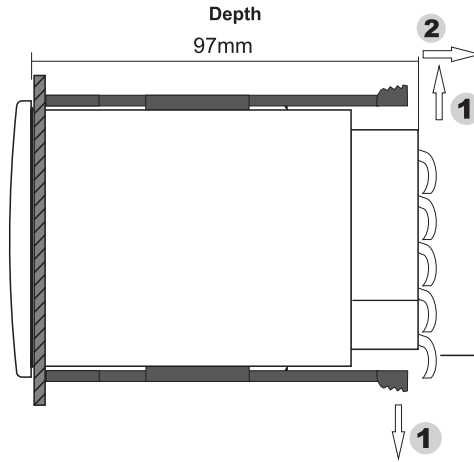
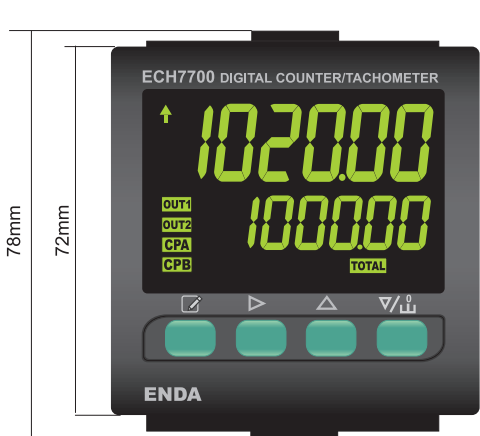

**To removing the device from the panel:**  
 - While pressing both side of the device in direction **1** and push it in direction **2** .

**NOTE:**

- 1) While performing panel mounting, additional space should be allocated for cables.
- 2) Panel thickness should be maximum **9mm**.
- 3) If there is no **100mm** free space at back side of the device, it would be difficult to remove it from the panel.

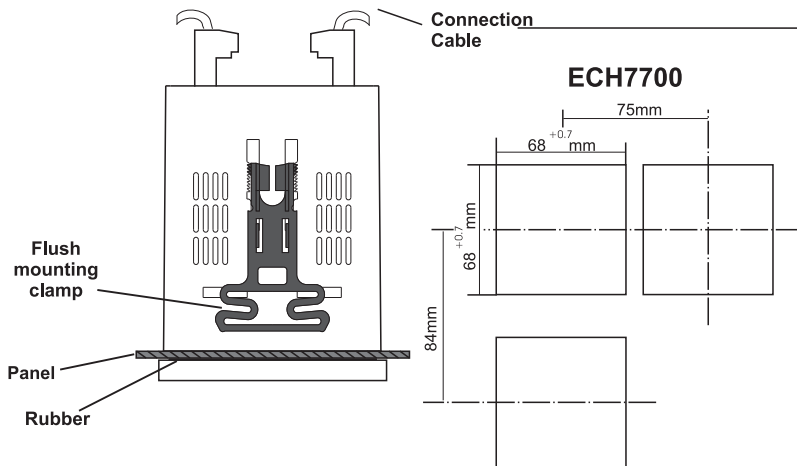



# ENDA ECHxx00 COUNTER/TACHOMETER MODBUS ADDRESS MAP

## 1.1 Counter/Tachometer Memory Map for Timer Holding Registers

Parameter Number	Holding Register Address Decimal (Hex)	Data Type	Data Content	Read /Write Permissions	Factory Settings		
Counter/Tachometer Configuration Parameters	H0	0000d (0000h)	Dword	Setpoint for Preset1 value. (Adjustable between 0-999999d. Format :32 Bit Hex = 0-999999d) First word LSW, second word MSW Sample: Adjusting for 550000d (86470h); LSW = 6470h, MSW = 0008h	RW	100000	
	H2	0002d (0002h)	Dword	Setpoint for Preset2 value. (Format must be as in the H0 parameter)	RW	200000	
	H4	0004d (0004h)	Word	Counter input type selection. (See TABLE.3 for adjustment)	RW	0	
	H5	0005d (0005h)	Word	Counter input frequency selection. 0 = 20Hz, 1 = 50Hz, 2 = 100Hz, 3 = 500Hz, 4 = 1000Hz, 5 = 5Khz 6 = 10Khz, 7 = 20Khz, 8 = 50Khz, 9 = 80Khz	RW	0	
	H6	0006d (0006h)	Word	Counter counting direction selection. 0 = Up counting, 1 = Down counting	RW	0	
	H7	0007d (0007h)	Word	Sensor type selection. 0 = NPN, 1 = PNP	RW	0	
	H8	0008d (0008h)	Word	Reset input pulse time selection. 0 = 1ms, 1 = 5ms, 2 = 20ms, 3 = 50ms, 4 = 100ms	RW	0	
	H9	0009d (0009h)	Dword	Setpoint for Calibration. (Adjustable between Format :32 Bit BCD = 1-999999) First word LSW second word MSW Sample: Adjustable between 150000 BCD (0150000h); LSW = 0000h, MSW = 0150h	RW	100000	
	H11	0011d (000Bh)	Word	Decimal point selection for Calibration. (0 = .000000, 1 = 0.00000, 2 = 00.0000)	RW	1	
	H12	0012d (000Ch)	Word	Tachometer input type selection. (See TABLE.8 for adjustment )	RW	0	
	H13	0013d (000Dh)	Word	Tachometer time base selection. (See TABLE.5 for setting )	RW	0	
	H14	0014d (000Eh)	Word	Tachometer pulse time selection. (See TABLE.6 for adjustment )	RW	3	
	H15	0015d (000Fh)	Word	Tachometer sampling time selection. Selectable between 0.20 s with 20.0 s.	RW	50	
	H16	0016d (0010h)	Word	Tachometer maximum sample time selection. Selectable between H8 and 99.99 s	RW	200	
	H17	0017d (0011h)	Word	Counter output type selection. ( See TABLE.4 for adjustment )	RW	0	
	Output Parameters	H18	0018d (0012h)	Word	Total Counter configuration selection. 0 = Total Counter disable, 1 = Counter input connects: Total Counter 2 = OUT1 output connects: Total Counter, 3 = OUT2 output connects: Total Counter	RW	0
		H19	0019d (0013h)	Word	Setpoint value selection for OUT1 0 = Preset1 OUT1 output value, 1 = Preset2 - Preset1 OUT1 output value	RW	0
H20		0020d (0014h)	Word	OUT1 output time setting. Adjustable between 0.0 and 999.9 sec. 0= continuously activated	RW	0	
H21		0021d (0015h)	Word	OUT2 output time setting. Adjustable between 0.0 and 999.9 sec. 0= continuously activated	RW	0	
H22		0022d (0016h)	Word	Tachometer output type select (See TABLE.9 for adjustment )	RW	0	
H23		0023d (0017h)	Word	Tachometer OUT1 output delay time. Adjustable between 0.0 and 999.9 sec.	RW	0	
H24		0024d (0018h)	Word	Tachometer OUT2 output delay time. Adjustable between 0.0 and 999.9 sec.	RW	0	
H25		0025d (0019h)	Dword	Decimal point selection parameter. 0 = Decimal point no, 1 = 0.0 , 2 = 0.00 , 3 = 0.000, 4 = 0.0000, 5 = 0.00000	RW	10	
H27		0027d (001Bh)	Word	Offset value (Format must be as in the H0 parameter)	RW	0	
H28		0028d (001Ch)	Word	Counter display configuration selection. (See TABLE.2 for adjustment )	RW	0	
Display Configuration Parameters	H29	0029d (001Dh)	Word	Tachometer display configuration selection. (Seen TABLE.7 for adjustment )	RW	0	
	H30	0030d (001Eh)	Word	Display brightness setting parameter. Adjustable between 1 and 20 .	RW	10	
	H31	0031d (001Fh)	Word	Counter/Tachometer selection parameter. ( 0 = Counter mode, 1 = Tachometer mode ).	RW	0	
	H32	0032d (0020h)	Word	Counter panel reset configuration selection. (See TABLE.1 for adjustment )	RW	0	
	H33	0033d (0021h)	Word	Counter reset input configuration selection. (See TABLE.1 for adjustment )	RW	0	
	H34	0034d (0022h)	Word	Tachometer panel reset configuration selection. (0 = No, 1 = Yes )	RW	0	
	H35	0035d (0023h)	Word	Tachometer reset input configuration selection. (0 = No, 1 = Yes )	RW	0	
	H36	0036d (0024h)	Word	When the energy is cut, measurement value stored. (0 = No, 1 = Yes )	RW	0	
	H37	0037d (0025h)	Word	Device address value for Modbus (Adjustable between 1 and 247)	RW	1	
	H38	0038d (0026h)	Word	Connection speed for Modbus: 0 = 1200 bps, 1 = 2400 bps, 2 = 4800 bps, 3 = 9600 bps, 4 = 14400 bps, 5 = 19200 bps, 6 = 38400 bps, 7 = 57600 bps	RW	3	
Device Configuration	H39	0039d (0027h)	Word	Counter/Tachometer configuration menu security parameter. Adjustable between 0 and 2. 0 = Menu invisible, 1 = Menu parameters is programmable, 2 = Menu parameters is only visible	RW	1	
	H40	0040d (0028h)	Word	Output parameters menu security parameter. Adjustable between 0 and 2 0 = Menu invisible, 1 = Menu parameters is programmable, 2 = Menu parameters is only visible	RW	1	
	H41	0041d (0029h)	Word	Display configuration menu security parameter. Adjustable between 0 and 2 0 = Menu invisible, 1 = Menu parameters is programmable, 2 = Menu parameters is only visible	RW	1	
	H42	0042d (002Ah)	Word	Device configuration menu security parameter. Adjustable between 0 and 2 0 = Menu invisible, 1 = Menu parameters is programmable, 2 = Menu parameters is only visible	RW	1	
	H43	0043d (002Bh)	Word	Preset 1 (H0) parameter security parameter. Adjustable between 1 and 2 1 = Menu parameters is programmable, 2 = Menu parameters is only visible	RW	1	
	H44	0044d (002Ch)	Word	Preset 2 (H2) parameter security parameter. Adjustable between 1 and 2 1 = Menu parameters is programmable, 2 = Menu parameter is only visible	RW	1	
	H45	0045d (002Dh)	Word	Function control parameter If ( 23040d ( 5A00h ) value is entered, device is returned to factory settings. If 23041d ( 5A01h ) value is entered, must be reset according to H33 value. If 23042d ( 5A02h ) value is entered, counting value is reset. If 23043d ( 5A03d ) value is entered, Total Counter reset If 23044d ( 5A04h ) value is entered, Batch counter reset If 23045d ( 5A05h ) value is entered, Tachometer values is reset	RW	0	
	Security Parameters						

# ENDA ECHxx00 COUNTER/TACHOMETER MODBUS ADDRESS MAP

## 1.2 Memory Map For Input Registers

Parameter Number	Input Register address Decimal (Hex)	Data Type	Data Content	Read / Write Permission
<b>I0</b>	0000d (0000h)	Dword	Counter counting values ( <b>Format :32 Bit Hex = Adjustable between -999999 and 999999d</b> ) First word LSW, second word MSW Sample: Reading value for 550000d (86470h); LSW = 6470h, MSW = 0008h.	R
<b>I2</b>	0002d (0002h)	Dword	Batch counter counting value ( <b>Format :32 Bit Hex = Adjustable 0 and 999999d</b> ) First word LSW, second word MSW Sample: If reading value is 550000d (86470h); LSW = 6470h, MSW = 0008h	R
<b>I4</b>	0004d (0004h)	Dword	Total Counter counting value ( <b>Format :32 Bit Hex = Adjustable between -999,999,999 and 999,999,999d</b> ) First word LSW, second word MSW	R
<b>I6</b>	0006d (0006h)	Dword	Counter hold value ( <b>Format is as in the I0 input register</b> )	R
<b>I8</b>	0008d (0008h)	Dword	Active Preset1 value ( <b>Format is as in the I2 input register</b> )	R
<b>I10</b>	0010d (000Ah)	Dword	Tachometer measurement value ( <b>Format is as in the I2 input register</b> )	R
<b>I12</b>	0012d (000Ch)	Dword	CPA pulse value ( <b>Format is as in the I2 input register</b> )	R
<b>I14</b>	0014d (000Eh)	Dword	CPB pulse value ( <b>Format is as in the I2 input register</b> )	R

## 1.3 Memory Map for Input Registerlers

Parameter Number	Holding Register addresses Decimal (Hex)	Data Type	Data Content	Read / Write Permission
<b>I0</b>	0000d (0000h)	Word	Timer1 time value ( <b>Must be read according to BCD format</b> )	R
<b>I1</b>	0001d (0001h)	Word	Timer2 time value ( <b>Format is as in the I0 parameter</b> )	R
<b>I2</b>	0002d (0002h)	Word	Out1 pulse time value ( <b>Must be read according to BCD format. Sensitivity 0.00sn</b> )	R
<b>I3</b>	0003d (0003h)	Word	Out2 pulse time value ( <b>Format is as in the I2 parameter</b> )	R

## 1.4 Memory Map for Output Status Indicator Bits

Parameter Number	Discrete input addresses	Data Type	Data Content	Read / Write Permission
<b>D0</b>	(0000)h	Bit	OUT1 Output status (0 = OFF ,1 = ON)	R
<b>D1</b>	(0001)h	Bit	OUT2 Output status (0 = OFF , 1 = ON )	R
<b>D2</b>	(0002)h	Bit	Panel reset key status ( 0 = Reset key inactive, 1 = Reset key is active )	R
<b>D3</b>	(0003)h	Bit	Reserve	R
<b>D4</b>	(0004)h	Bit	Reset input status ( 0 = Reset input inactive, 1 = Reset input is active )	R
<b>D5</b>	(0005)h	Bit	Gate input status ( 0 = Gate input inactive, 1 = Gate input is active )	R
<b>D6</b>	(0006)h	Bit	Start input status ( 0 = Start input inactive, 1 = Start input is active )	R
<b>D7-D15</b>	0007d (0007h) ..... 0015d (000Fh)	Bit	Reserve	R

## 1.5 Memory Map for Software Revision Input Registers

Software Revision	0920d (0398h)	14 Word	Software name and update date is in ASCII format and 14 word. Example : EM4400-01 28 Feb 2015. Memory Format : <div style="text-align: center;"> <table border="1" style="margin: auto;"> <tr> <td>Word</td><td>1</td><td>2</td><td>3</td><td>4</td><td>5</td><td>6</td><td>7</td><td>8</td><td>9</td><td>10</td><td>11</td><td>12</td><td>13</td><td>14</td> </tr> <tr> <td></td><td>C</td><td>E</td><td>4</td><td>4</td><td>0</td><td>0</td><td>0</td><td>-</td><td>1</td><td></td><td></td><td></td><td></td><td>4</td><td>2</td><td>A</td><td>g</td><td>u</td><td>2</td><td>1</td><td>0</td><td>.</td><td>6</td> </tr> </table> </div>	Word	1	2	3	4	5	6	7	8	9	10	11	12	13	14		C	E	4	4	0	0	0	-	1					4	2	A	g	u	2	1	0	.	6	R
Word	1	2	3	4	5	6	7	8	9	10	11	12	13	14																													
	C	E	4	4	0	0	0	-	1					4	2	A	g	u	2	1	0	.	6																				
<b>NOTE :</b> To view each word correctly by changing the byte sequences should be displayed as ASCII TEXT																																											

## 2. MODBUS ERROR MESSAGES

Modbus protocol has two types error, communication error and operating error. Reason of the communication error is data corruption in transmission. Parity and CRC control should be done to prevent communication error. Receiver side checks parity and CRC of the data. If they are wrong, the message will be ignored. If format of the data is true but function doesn't perform for any reason, operating error occurs. Slave realizes error and sends error message. Most significant bit of function is changed '1' to indicate error in error message by slave. Error code is sent in data section. Master realizes error type via this message.

### ModBus Error Codes

Error Code	Name	Meaning
01	ILLEGAL FUNCTION	The function code received in the query is not an allowable action for the slave. If a Poll Program Complete command was issued, this code indicates that no program function preceded it.
02	ILLEGAL DATA ADDRESS	The data address received in the query is not an allowable address for the slave.
03	ILLEGAL DATA VALUE	A value contained in the query data field is not an allowable value for the slave.

Message example;

Structure of command message (Byte Format)

Device Address		(0A)h
Function Code		(01)h
Beginning address of coils.	MSB	(04)h
	LSB	(A1)h
Number of coils (N)	MSB	(00)h
	LSB	(01)h
CRC DATA	LSB	(AC)h
	MSB	(63)h

Structure of response message (Byte Format)

Device Address		(0A)h
Function Code		(81)h
Error Code		(02)h
CRC DATA	LSB	(B0)h
	MSB	(53)h

As you see in command message, coil information of (4A1)h = 1185 is required but there isn't any coil with 1185 address. Therefore error code with number (02) (Illegal Data Address) sends.

